

LCSD

USER GUIDE

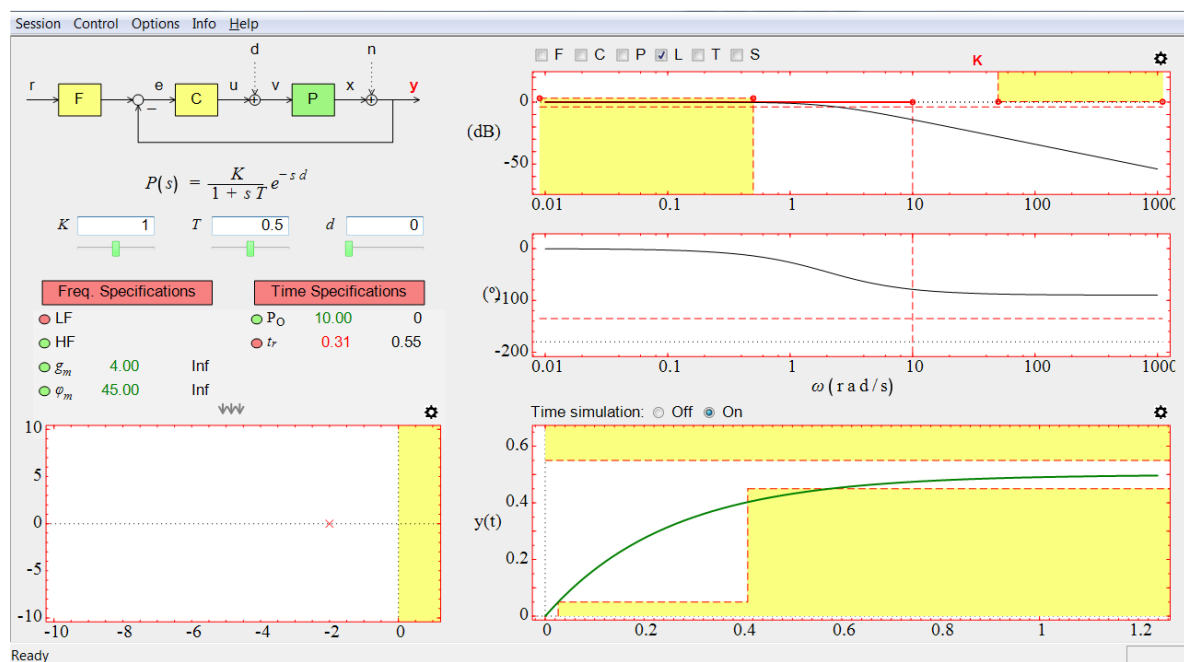

José Manuel Díaz Martínez

Sebastián Dormido Bencomo

Rocio Muñoz Mansilla



June 13, 2019

LCSD User Guide.

ISBN:

Copyright © 2019 José Manuel Díaz Martínez, Sebastián Dormido Bencomo and Rocio Muñoz Mansilla

All rights reserved. No part of this guide may be copied or reproduced without the permission in writing of the authors.

Departamento de Informática y Automática

E.T.S.I Informática.

Universidad de Educación a Distancia (UNED).

C/ Juan del Rosal nº 16. Madrid 28040 (España)

Changes added to the user guide (June 13, 2019)

- Controller configuration (Section 3, pages 7-9). The controller configuration has been updated.

INDEX

| | |
|--|----|
| 1. About LCSD | 1 |
| 2. Plant configuration | 1 |
| 3. Controller configuration | 7 |
| 4. Prefilter configuration | 9 |
| 5. Inputs configuration | 9 |
| 6. Poles-zeros map | 11 |
| 7. Root locus | 14 |
| 8. Frequency response | 15 |
| 9. Time response | 19 |
| 10. Frequency performance/specifications | 21 |
| 11. Time performance/specifications | 29 |
| 12. Save, load, and compare controllers | 34 |
| 13. Save and load a work session | 35 |
| 14. Save a report | 35 |
| 15. Menu options | 36 |
| Appendix A: Colour code | 39 |
| Appendix B: Keyboard shortcuts | 39 |
| Bibliography | 40 |

1. About LCSD

LCSD (Interactive Tool for Control System Education) is an interactive software tool for the teaching and learning of the basic concepts of analysis and design of control systems. LCSD has been developed with Sysquake 6.0 [Piguet, 2017] by José Manuel Díaz Martínez (UNED) and Sebastián Dormido Bencomo (UNED). It can be downloaded for Windows and Mac platforms from the following link:

<http://www2.uned.es/itfe/LCSD/LCSD.html>

2. Plant configuration

To select the plant structure, the user has to double click on the block P of the *block diagram* zone, which is located at the left upper corner of the main window (see Figure 1). When the user performs this action, an auxiliary window is shown in the screen (see Figure 2) with all the available plant structures. LCSD has thirteen plant structures: twelve predefined (rows 1 to 3) and one user-defined (row 4). The user has to click on the desired structure (the block takes a light green colour), and pulse the button OK.

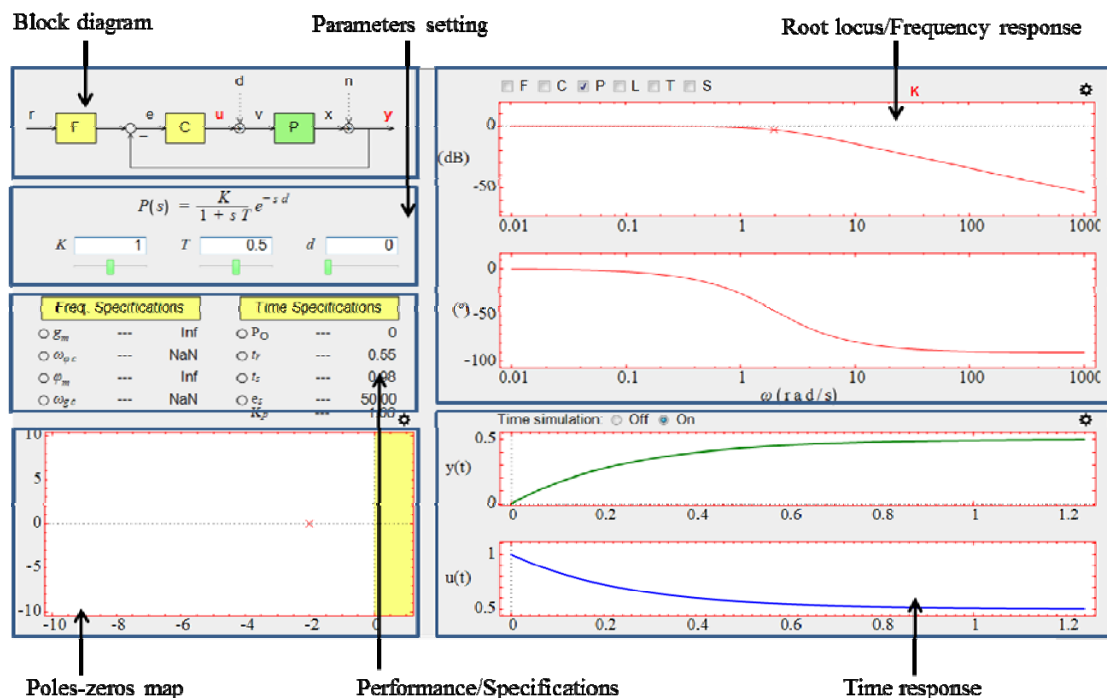

Figure 1. LCSD main window

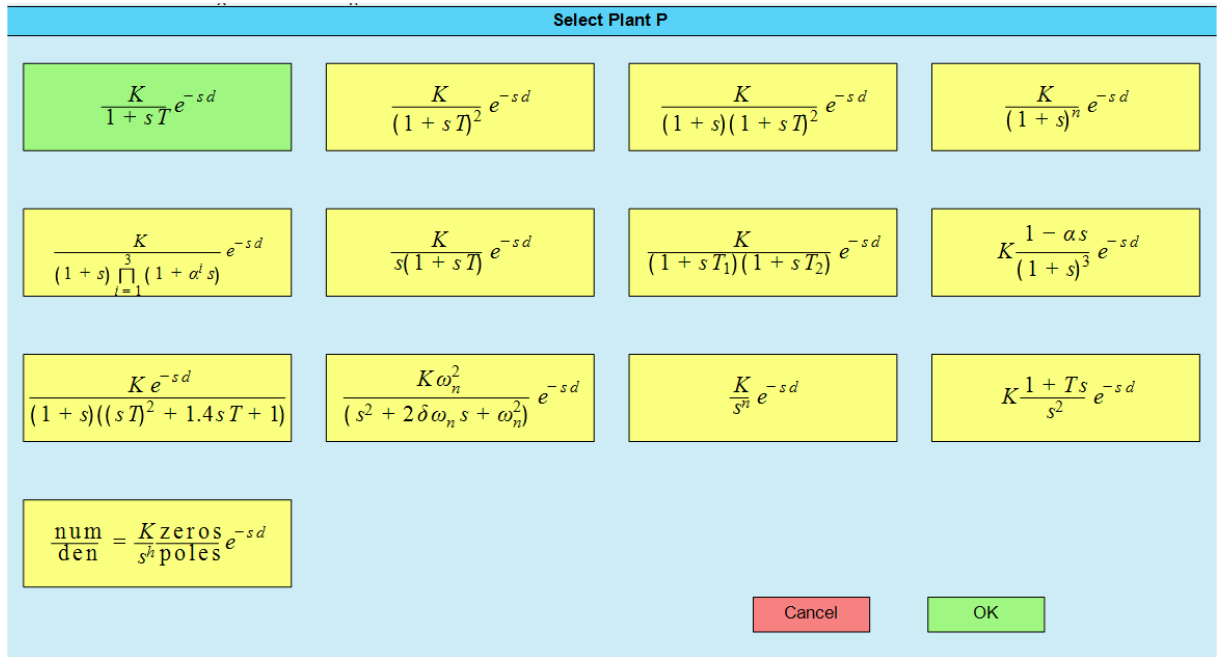

Figure 2. Auxiliary window to select the plant structure

The plant parameters can only be set if the block P of the *block diagram* zone has been previously selected, i.e., the block is in light green colour. To select a block, the user has to click on it. LCSD allows the user to set the plant parameters from three zones (see Figure 1):

- Parameters setting.* In this zone, there are text fields and sliders to configure the plant parameters. To insert a value in a text field the user has to click on it, write the value, and pulse the {Enter} key. To configure a plant parameter by a slider, the user has to locate the mouse pointer on the slider, hold down the mouse left button, drag left or right, and release the button. Note that, depending on the parameter, some values are not allowed. In this case, the value is not taken, or a dialog box is shown with a warning message.
- Poles-zeros map and root locus.* In this zone, the following interactive elements are plotted: 'x' (real pole or integrator), bold 'x' (complex pole), 'o' (real zero or derivator), and bold 'o' (complex zero). Besides, the following colour code is used: red (plant P), blue (controller C), and blue (prefilter F). The user can drag the interactive elements to configure the poles and zeros. To drag an interactive element, the user has to place the mouse pointer on the element, hold down the mouse left button, drag the element to the desired position, and release the

button. Note that, depending on the transfer function structure, some interactive elements cannot be dragged.

- *Frequency response.* In this zone, the following interactive elements are plotted: 'x' (real pole corner frequency), bold 'x' (complex pole corner frequency), 'o' (real zero corner frequency, and bold 'o' (complex zero corner frequency). Besides, the following colour code is used: red (plant P), blue (controller C), blue (prefilter F), black (open-loop transfer function L), green (closed-loop transfer function $T=L/(1+L)$), black ($F \cdot T$), and grey (sensitivity $S=1/(1+L)$). The user can drag the interactive elements to configure the corner frequencies (and the damping factor in a complex pole or zero). To drag an interactive element, the user has to locate the mouse pointer on the element, hold down the mouse left button, drag the element to the wanted position, and release the button. Note that, depending on the transfer function structure, some interactive elements cannot be dragged.

If the user selects a user-defined plant (see Figure 3) in the auxiliary window (see Figure 2), the *parameters setting* zone takes, by default, the appearance of the Figure 4a.

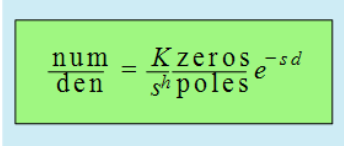

$$\frac{\text{num}}{\text{den}} = \frac{K \text{ zeros}}{s^h \text{ poles}} e^{-s d}$$

Figure 3. Icon of the user-defined plant in the auxiliary window of the Figure 2

The zone shows an interactive symbolic transfer function. Below the transfer function, the user can see information about it.

The interactive symbolic transfer function allows the user to configure the transfer function, and to control the information that is shown in the *parameters settings* zone. The user can do the following actions on the interactive transfer function:

- Click on $\frac{\text{num}}{\text{den}}$. The numerical transfer function is shown below of the symbolic transfer function (see Figure 4a).
- Click on *zeros*. The plant zeros are displayed below the symbolic transfer function (see Figure 4b).

- Click on **poles**. The plant poles are displayed below the symbolic transfer function (see Figure 4c).
- Click on $\frac{K}{s^h}$ or e^{-sd} . Three text fields and sliders are displayed (see Figure 4d) to configure the plant gain K , the number of integrators or derivators h , and the plant delay d , respectively.
- Double click on $\frac{\text{num}}{\text{den}}$. A dialog box is shown to enter the polynomials of the numerator and the denominator.
- Double click on **zeros**. A dialog box is shown to enter the plant zeros.
- Double click on **poles**. A dialog box is shown to enter the plant poles.

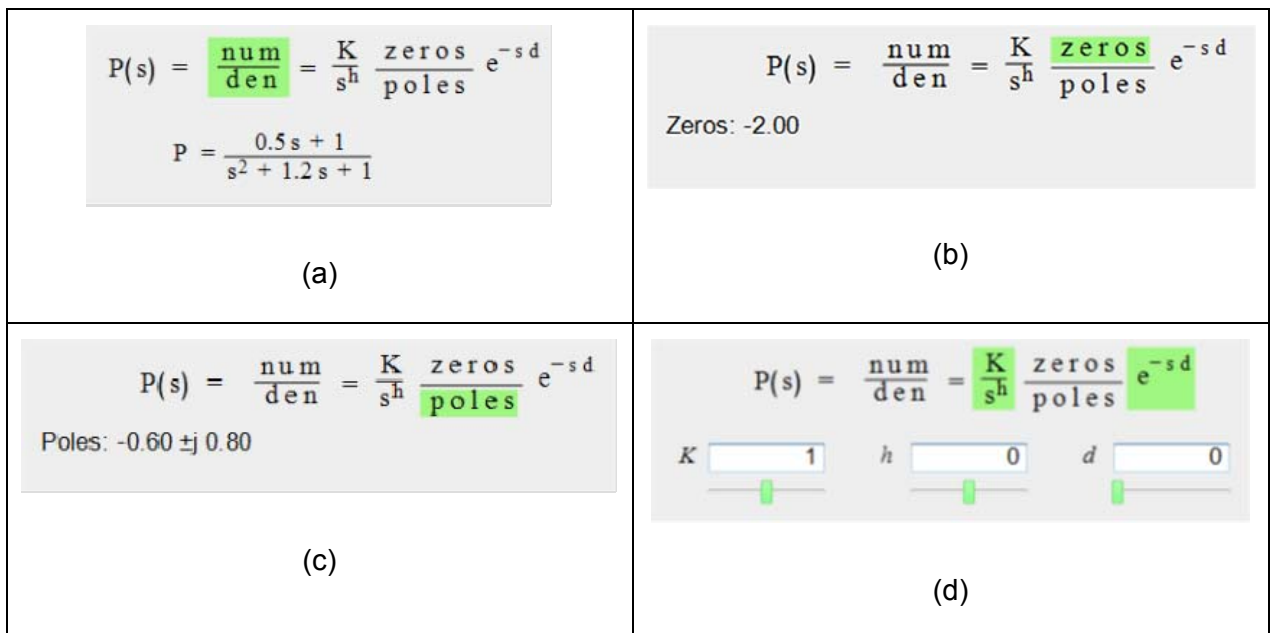

Figure 4. Possible appearances of the *Parameters settings* zone when the user-defined plant is selected

The user can also do the following actions with the information displayed below the symbolic transfer function:

- Click on a zero or pole. If it is real, then two text fields and sliders are displayed to configure the real part Re or the time constant T . If it is complex, then four text fields and sliders are displayed to configure the real part Re , the imaginary part Im , the damping factor δ , and the natural frequency ω_n .
- Double click on a zero or pole. The element is removed from the transfer function. Note that a pole can be only removed if the new plant is strictly proper, i.e., the denominator degree is greater than the numerator degree.
- Because of space limitations, only nine zeros or poles can be displayed simultaneously. The zeros or poles are sorted in increasing order of real part. If the number of zeros or poles is greater than nine, then the symbols '<' and '>' are displayed in the right lower corner of this zone. The user can click on '<' or '>' to move the zeros or poles to the left or to the right.

By default, LCSD provides a user-defined plant P with a real zero and a pair of conjugate complex poles. The user can change this plant structure from the following zones:

- The symbolic transfer function of the *parameters settings* zone. The user can modify the plant numerator, denominator, poles, and zeros by double clicking on $\frac{\text{num}}{\text{den}}$, zeros, or poles..
- The *poles-zeros* zone. In the central upper part of this zone (see Figure 5a), there is an interactive repository where the user can do the following actions:
 - Drag an element from the repository to the poles-zeros map. This action adds the element to the plant structure. To drag an element, the user has to locate the mouse pointer on the element, hold down the mouse left button, drag the element to the wanted position inside the poles-zeros map, and release the button. Note that a zero or derivator can be only added if the new plant is strictly proper, i.e., the denominator degree is greater than the numerator degree.

- Drag an element from the poles-zeros map to the repository. This action removes the element from the plant structure. Note that a pole or integrator can be only removed if the new plant is strictly proper, i.e., the denominator degree is greater than the numerator degree.
- The *frequency response* zone. In the right upper part of this zone (see Figure 5b), there is an interactive repository with a functionality similar to the repository in the poles-zeros map (see the previous paragraphs). The only difference is the element K (Gain). When the user clicks on this element, a light green square is drawn around it, that means that the user can configure the gain of the frequency response (see Section 8).

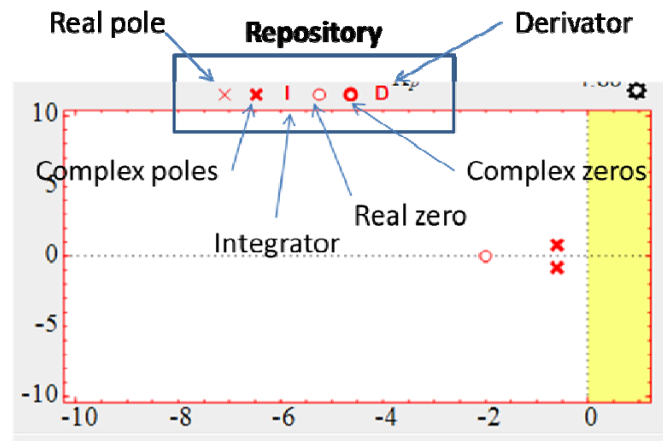

(a)

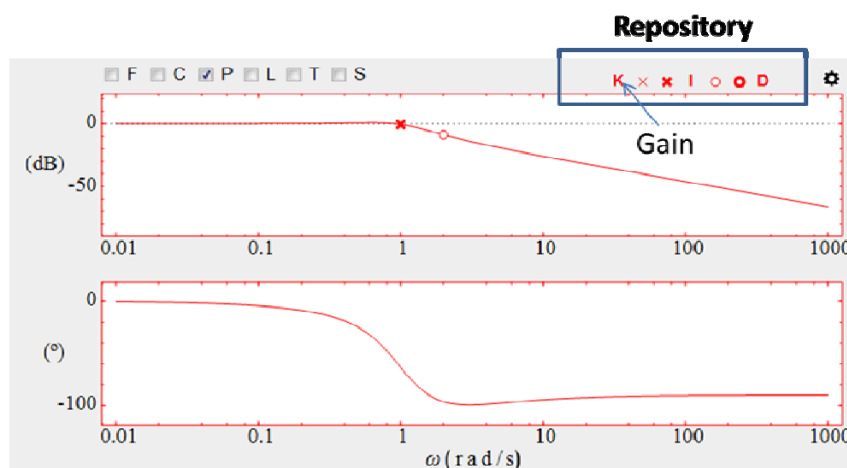

(b)

Figure 5. Repository of elements to configure an user-defined plant in: a) *poles-zeros map zone*, b) *Frequency response zone*

3. Controller configuration

To configure the controller, the user has to double click on the block C of the block diagram zone, which is located in the left upper corner of the main window (see Figure 1). When the user does this action, an auxiliary window is shown (see Figure 6) with all the available controllers. LCSD has six controllers: five predefined and one user-defined.

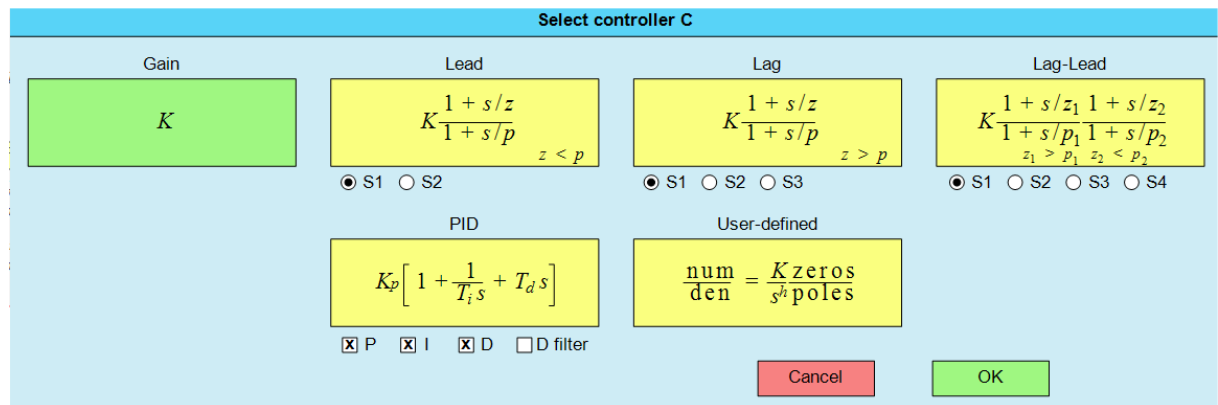

Figure 6. Auxiliary window to select the controller structure

User has to click on the wanted controller, the block takes a light green colour. In the case of lead, lag, and lag-lead controllers, user can choose different types of structures SX, where X=1, 2, 3, or 4. He/she only has to click on a radio button SX to choose the wanted structure. In the case of PID controller, user can also select the actions that he wants to enable: proportional (P), integral (I), derivative (D), or filter derivative (D filter). Once, the controller has been selected, user has to pulse the button OK.

The controller parameters can only be set if the block C of the *block diagram* zone has been previously selected, i.e., the block is in light green colour. To select a block, the user has to click on it. The controller parameters settings are very similar to the plant parameters settings (see section 2).

One difference is that when the user selects a gain, lead, lag, lag-lead, or PID controller in the auxiliary window (see Figure 6), the *parameters setting* zone takes, by default, an appearance similar to the Figure 7a. The zone shows an interactive symbolic transfer function. Below the transfer function, the user can see its parameters, zeros, and poles. The interactive symbolic transfer function allows the user to configure the transfer function, and to control the information that is shown in the *parameters settings* zone.

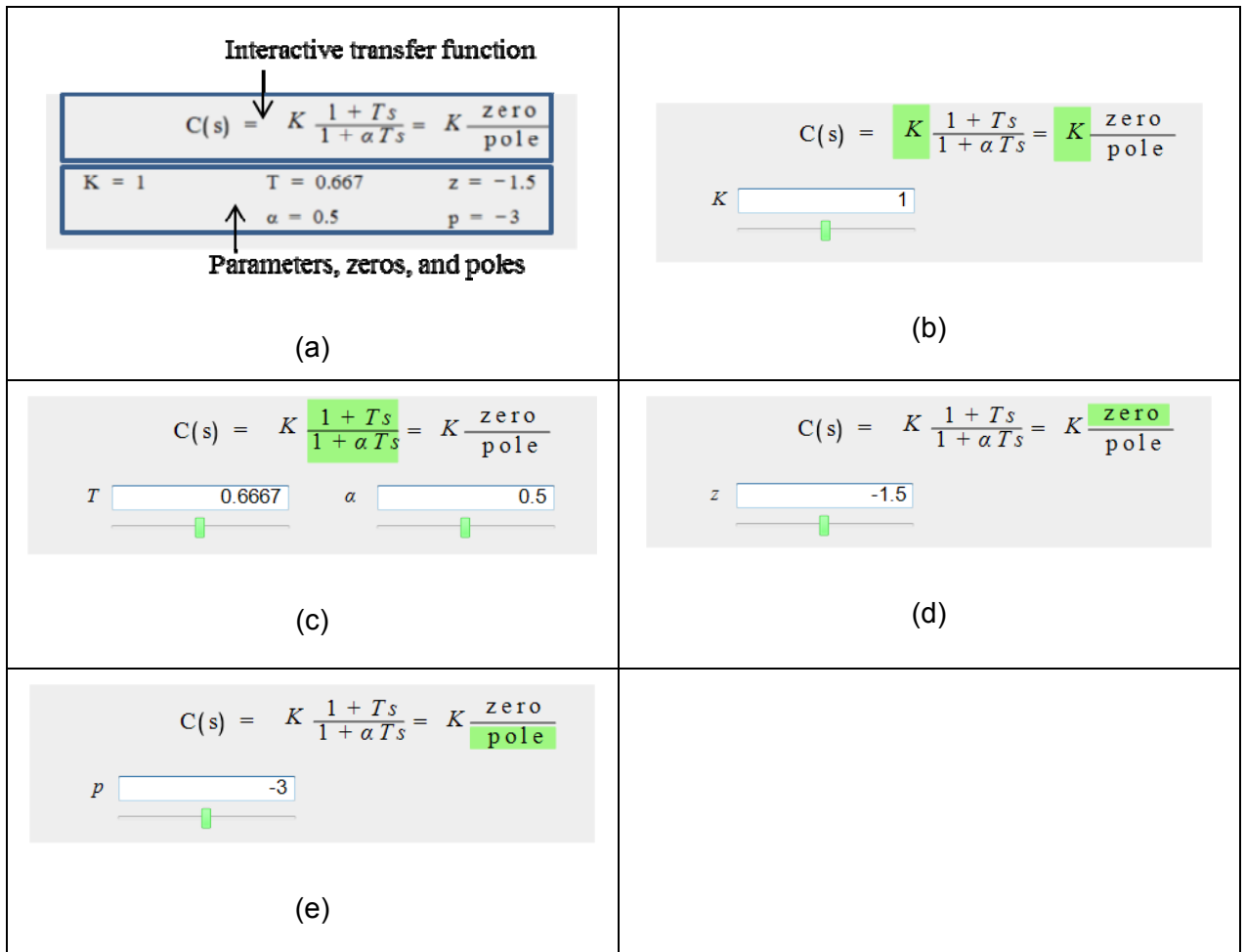

Figure 7. Example of possible appearances of the *Parameters settings zone* when a controller is selected

The user can do the following actions on the interactive transfer:

- Click on K . A text field and slider are displayed (see Figure 7b) to configure the plant gain K .
- Click on $\frac{\text{num}}{\text{den}}$. Text fields and sliders are displayed (see Figure 7c) to configure the controller parameters.
- Click on zeros. Text fields and sliders are displayed (see Figure 7d) to configure the controller zeros.
- Click on poles. Text fields and sliders are displayed (see Figure 7e) to configure the controller zeros.

- Click on $C(s)$. The parameters, zeros and poles are shown below of the symbolic transfer function (see Figure 7a).

Note that user can also click on the parameters, zeros (z), or poles (p) that are shown below the symbolic transfer function (see Figure 7a). In this case, the corresponding textfields and sliders are shown to configure them.

In the case of a user-defined controller, the parameters settings are similar to the user-defined plant parameters settings (see section 2). The only difference is that controller transfer function can have the same number of zeros and poles.

LCSD draws the controller elements (poles, zeros, corner frequencies, magnitude, phase, ...) in blue.

4. Prefilter configuration

The configuration of the prefilter F is similar to the controller C (see section 3). LCSD draws the prefilter elements (poles, zeros, corner frequencies, magnitude, phase, ...) in light blue.

5. Inputs configuration

This version of LCSD implements in the *block diagram* zone a classical control system of two degrees of freedom that has three inputs: reference r , plant input disturbance d , and plant output disturbance n . By default, d and n are disabled; and their arrows are drawn in dotted line (see Figure 8). To enable a disturbance (d or n), the user has to click on the corresponding arrow. When a disturbance is enabled, its arrow is drawn in solid line (see Figure 9). To disable a disturbance, the user also has to click on its arrow.

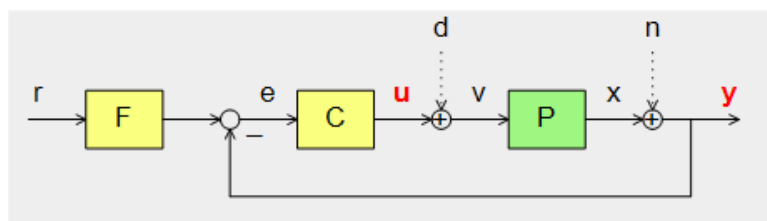

Figure 8. *Block diagram* zone, the inputs d and n are disabled (their arrows are drawn in dotted line)

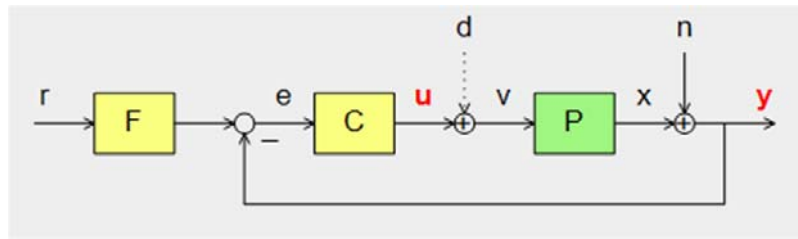

Figure 9. *Block diagram* zone, the disturbance d is disabled, and the disturbance n is enabled (its arrow is drawn in solid line).

LCSD implements six types of inputs: pulse, step, ramp, parabola, sinusoid, and white noise. To select the type of an input, the user has to double click on the label associated to an input. For example, to select the type of the reference r , the user has to double click on the label r in the block diagram zone. When the user does this action, an auxiliary window is shown in the screen (see Figure 10) with all the available types of inputs. The user only has to click on the desired type (light green) and click on the OK button.

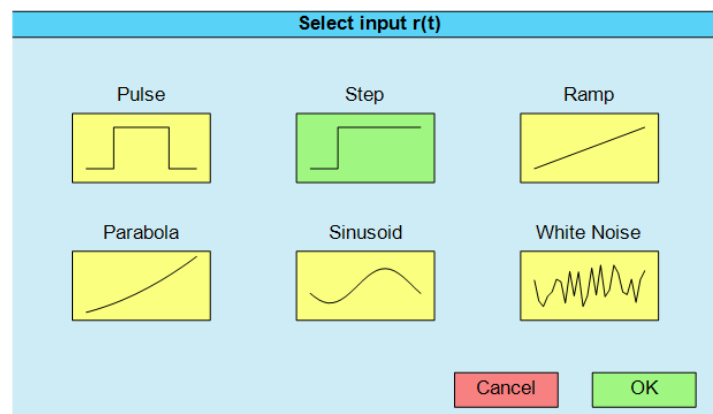

Figure 10. Auxiliary window to select the type of an input

To configure the parameters of an input (r , d or n), the user has to click on the corresponding label in the *block diagram* zone. Notice that a light green square is drawn around the label. The parameters of an input can be configured in the *parameters settings* zone by text fields or sliders. For example, suppose that the user clicks on the label r in the block diagram zone (see Figure 11), the label r is enclosed within a light green square. In this example, the reference is a step. This type of input has two parameters: the amplitude a and the delay d . There are two text fields and sliders in the *parameters settings* zone to configure these parameters.

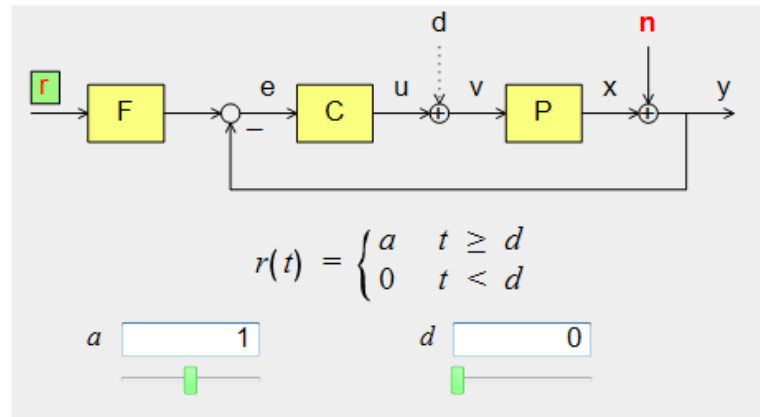

Figure 11. Configuration of the parameters of an input

6. Poles-zeros map

The *poles-zeros map* zone is located in the left bottom corner of the main window (see Figure 1).

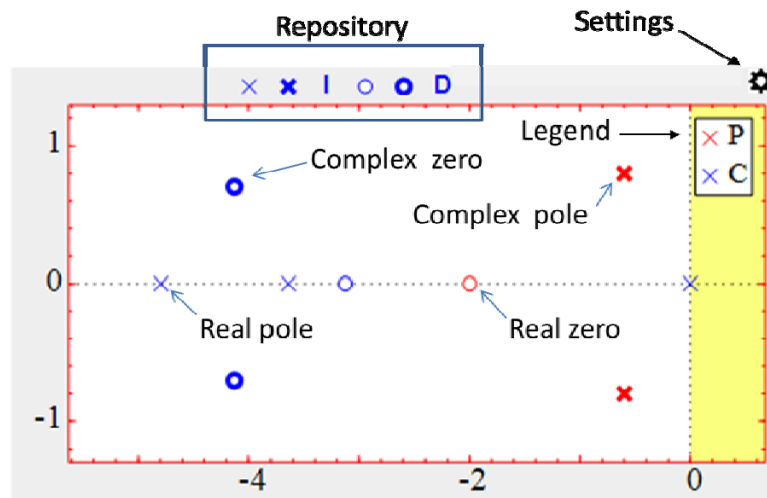

Figure 12. Interactive elements of the zone *poles-zeros map*

In this zone, the following interactive elements are available (see Figure 12):

- Poles and zeros. The following symbols are used: 'x' (real pole or integrator), bold 'x' (complex pole), 'o' (real zero or derivator), and bold 'o' (complex zero). The following colour code is used: red (plant $P(s)$), blue (controller $C(s)$ or prefilter $F(s)$), and green (complementary sensitivity function $T(s)$). To drag pole or zero, the user has to locate the mouse pointer on the element, hold down the

mouse left button, drag the element to the wanted position, and release the button. Note that to drag an interactive elements (poles or zeros) of a certain transfer function (plant, controller, or prefilter), the corresponding block in the *block diagram* zone has to be selected (light green colour). Besides, depending on the transfer function structure, some interactive elements cannot be dragged.

- Repository. The user can do the following actions with this interactive element:
 - Drag an element (pole or zero) from the repository to the poles-zeros map. This action adds the element to the transfer function. To drag an element, the user has to locate the mouse pointer on the element, hold down the mouse left button, drag the element to the wanted position inside the poles-zeros map, and release the button. Note that a zero can be only added if the transfer function has a number of poles greater than zeros.
 - Drag an element (pole or zero) from the poles-zeros map to the repository. This action removes the element from the transfer function. Note that a pole can be only removed if the number of zeros is lower to the number of poles.
- Legend. By default, it is located in the upper right corner of the poles-zeros map. The user can change the position of the legend to any corner of the poles-zeros map. To do that, he/she has to locate the mouse pointer on the legend, hold down the mouse left button, and drag the legend to the wanted corner. Besides, the legend can be hidden by the corresponding option in the pole-zero map settings.
- Settings. It is located in the upper right corner of the zone, and is represented by a gearwheel icon. When the user clicks on this icon, an auxiliary window is shown (see Figure 13). It allows hiding the legend and configuring the scale of the poles-zeros map. The user can select the type of scale by clicking on the corresponding radio button:
 - *Locked*. The axes limits are set by the user in the text fields and sliders of the auxiliary window.
 - *Variable*. The axes limits are set automatically by LCSD to display all the poles and zeros.

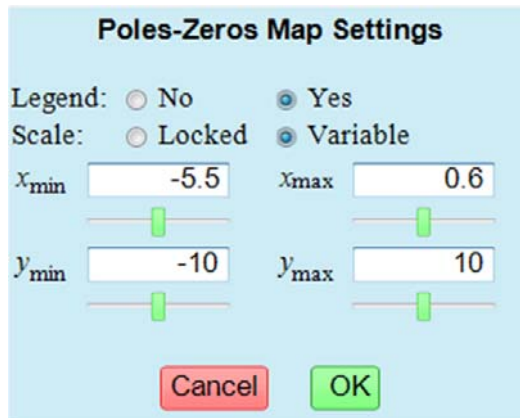

Figure 13. Auxiliary window to configure the scale of the poles-zeros map

7. Root locus

The *root locus/frequency response* zone is located in the right upper corner of the main window (see Figure 1). The user has to type the key {r} to visualise the root locus in this zone, because the Bode plot is shown in this zone by default.

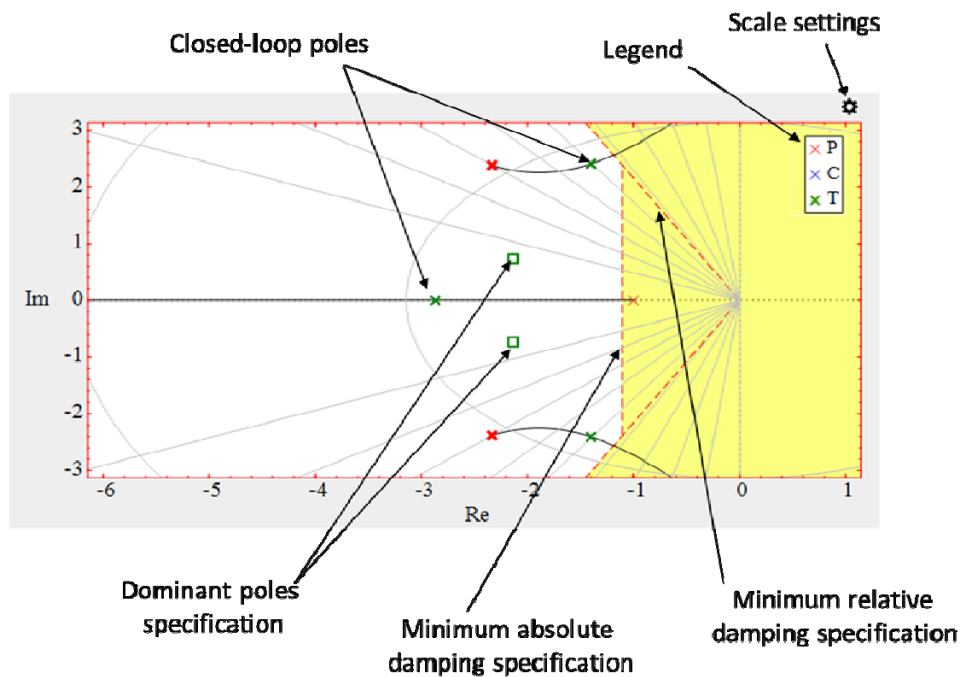

Figure 14. *Root locus* zone

In this zone, the following elements are drawn (see Figure 14):

- Poles and zeros of the plant and the controller. They are drawn in the same way as in the poles-zeros map (see section 6). Note that the user can also drag these elements in this zone.
- Root locus branches. They are drawn in black solid line.
- Closed-loop poles. They are represented with green 'x'. The user can configure the closed-loop gain by dragging them on the root locus branches.
- Closed-loop dominant poles specification. They are represented with green '□'. If the auxiliary window of the time specification is opened (see Section 11), the user can drag them to configure the specification.
- Minimum absolute damping specification. It is represented by a yellow area that is limited with a red dotted vertical line. If the auxiliary window of the time specification is opened (see Section 11), the user can drag this line horizontally to the left or to the right in order to configure this specification.
- Minimum relative damping specification. It is represented by a yellow area that is limited with two red dotted lines. If the auxiliary window of the time specification is opened (see Section 11), the user can drag these lines to configure this specification.

To configure the scale of the *root locus* zone, the user has to click on the gearwheel icon located in the right upper corner of the zone (see Figure 14). When the user does this action, an auxiliary window is shown (see Figure 15). There are two types of scale:

- *Locked* scale. If the checkmark *Equal* is not marked, then the user can set the axes limits in the textfields and sliders of the auxiliary window.
- *Variable* scale. The axes limits are set automatically by LCSD to display all the poles and zeros.

The user can select the type of scale by clicking on the corresponding radiobutton: *locked* or *variable*. If the user selects the checkmark *Equal*, then the same linear scale is used for *x* and *y* axes.

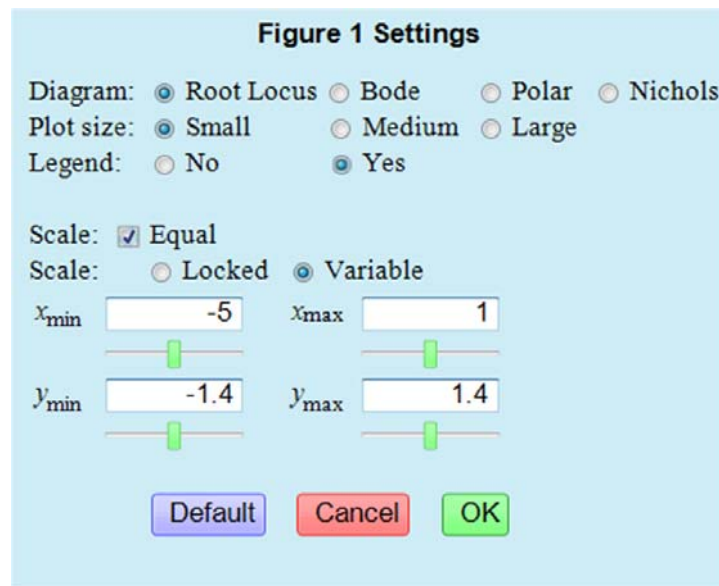

Figure 15. Auxiliary window to configure the scale of the root locus zone

8. Frequency response

The *frequency response* zone is located in the right upper corner of the main window (see Figure 3). The user has to type the key {b} to display the Bode diagram, the key {p} to display the polar (Nyquist) diagram, or the key {n} to display the Nichols diagram. The size of this zone can also be set by the keys: {1} small, {2} medium, and {3} large.

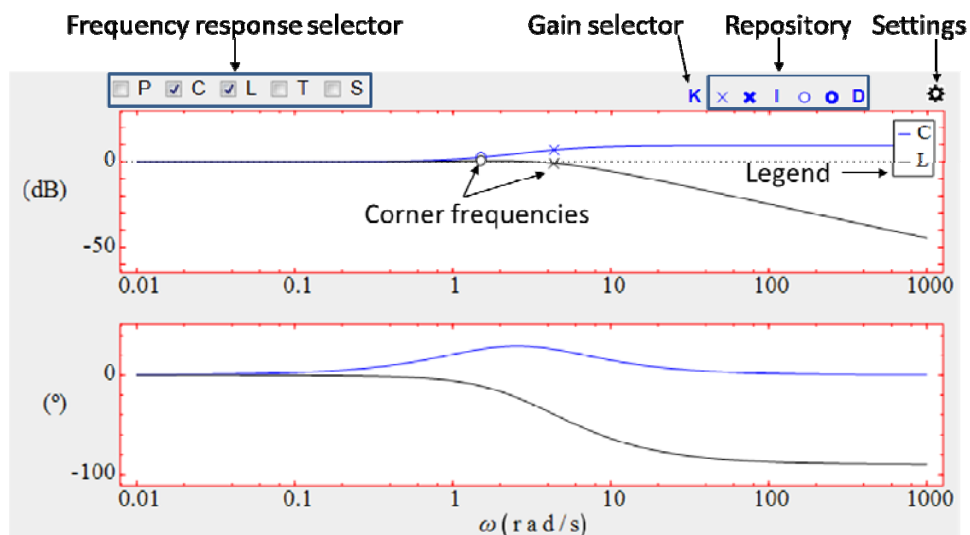

Figure 16. Frequency response zone with a Bode plot diagram

It is also possible to select the type and size of the frequency response diagram clicking on the gearwheel icon located in the right upper corner of the zone (see Figure 16 and Figure 19)

In this zone, the following elements are available (see Figure 16):

- Magnitude, phase, polar and nichols curves for the prefilter F (blue), the controller C (blue), the plant P (red), the open-loop transfer function $L=P \cdot C$ (black), the closed-loop transfer function $T=L/(1+L)$ (dark green), the transfer function $F \cdot T$ (black), and the sensibility transfer function $S=1/1+L$ (grey). The user can choose the curves that are plotted by the selector located in the left upper square (see Figure 16). These curves are plotted in solid lines. If a controller has been loaded to compare (see Section 12), then their curves are plotted in dashed lines. Note that the available functions in the selector depend on the selected block in the *block diagram* zone. For example, when the block C is selected, then the available functions in the selector are P , C , L , T , and S (see Figure 16).
- Gain selector. It is located in the central upper part of the zone. To enable or disable the selector, the user has to click on it. When the gain selector is enabled, it is enclosed within a light green square (see Figure 17), and the user can configure the gain of the frequency response. To increase (or decrease) the gain, the user has to drag vertically upward (or downward) the Bode magnitude curve, the polar curve, or the Nichols curve. Once the user has finished configuring the gain, he/she has to click on the gain selector to disable it.

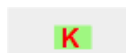

Figure 17. Enabled gain selector

- Corner frequencies. They are represented with the following interactive elements: 'x' (real pole corner frequency), bold 'x' (complex pole corner frequency), 'o' (real zero corner frequency, and bold 'o' (complex zero corner frequency). The used colour code is the same that has been described in the previous paragraph. Note that only the corner frequencies of the block selected (light green colour) in the *block diagram* zone are plotted. To configure the corner frequency of a pole ('x') or a zero ('o'), the user has to locate the mouse pointer on the interactive element, and drag the element to the desired position. A corner frequency can only be

dragged horizontally to the left (or to the right). Figure 18 shows the meaning of the displacements in bode diagram, polar diagram, and Nichols diagram.

Note that to configure the parameters of the controller C , the user can work on the interactive elements of C or L . Likewise, to configure the parameters of the prefilter F , the user can work on the interactive elements of F or $F.T$.

When the user finishes a drag operation, LCSD updates the information in all the zones of the main window. If the time simulation takes a long time, in order to short the update, the user should disable the time simulation (see Section 9).

- Damping ratio δ of a pair of complex poles or zeros. To configure the damping ratio of a pair of complex poles ('x') or zeros ('o') in the bode magnitude plot, the user has to locate the mouse pointer on the interactive element, and drag vertically upward or downward (see Figure 18).

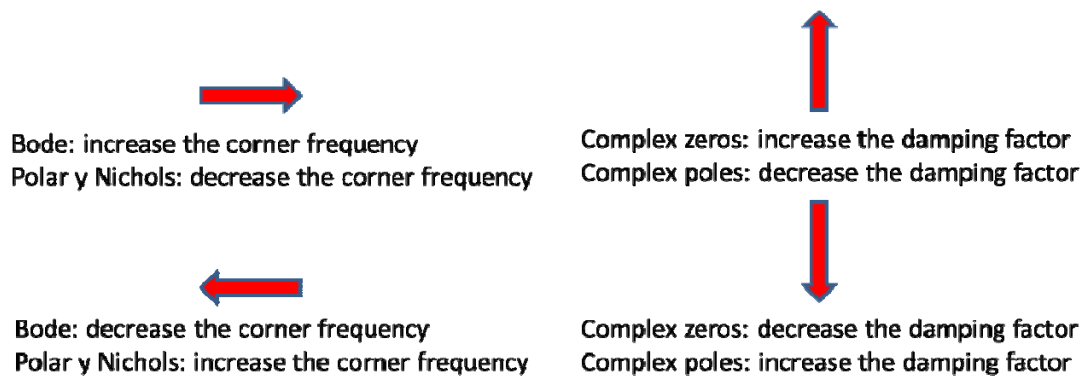

Figure 18. Meaning of the displacements in bode magnitude diagram, polar diagram, and Nichols diagram

- Frequency specifications. These specifications are described in section 10.
- Repository and legend. The functionality of these elements is described in section 6.
- Settings. It is located in the upper right corner of the zone, and is represented by a gearwheel icon. When the user clicks on this icon, an auxiliary window is shown (see Figure 19) to choose several options of the frequency response: type of diagram (Bode, polar, or Nichols), size (small, medium, or large), the visualization of the legend, the scale, the visualization of the frequency response points, and the number of points. There are two types of scale:

- *Locked* scale. If the checkmark *Equal* is not marked (this condition is only necessary in the polar diagram), then the user can set the axes limits in the text fields and sliders of the auxiliary window. The following nomenclature is used: magnitude in dB (M), phase in degrees (P), frequency in radians per second (ω).
- *Variable* scale. The axes limits are set automatically by LCSD to display all the poles and zeros.

The user can select the type of scale by clicking on the corresponding radio button: *locked* or *variable*. In the polar diagram, if the user selects the checkmark *Equal*, then the same linear scale is used for x and y axes.

Besides, in this auxiliary window, the user can configure the points number N_ω that are plotted in the frequency response. N_ω must be an integer in the range [50,2000]. If N_ω is greater than 500, then the computational burden increases, and the interactivity gets worse. The user can also choose whether or not to shown these points on the frequency response. In affirmative case, if the user locates the mouse pointer on a point, its coordinates are displayed.

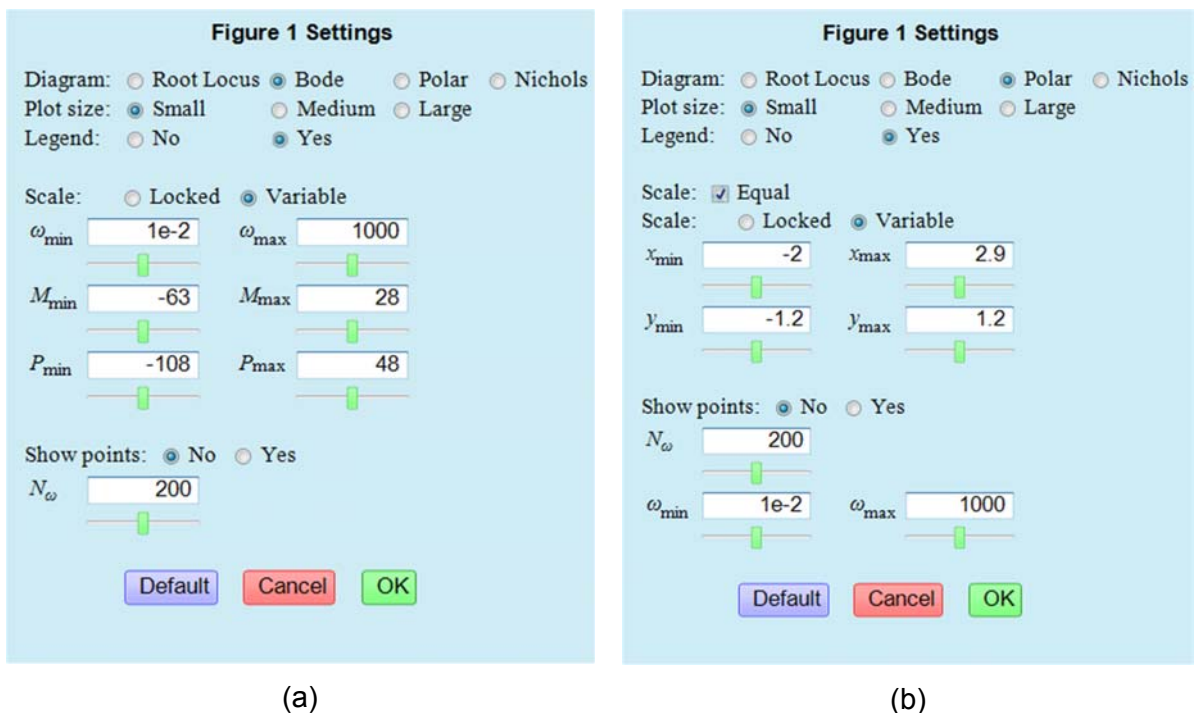
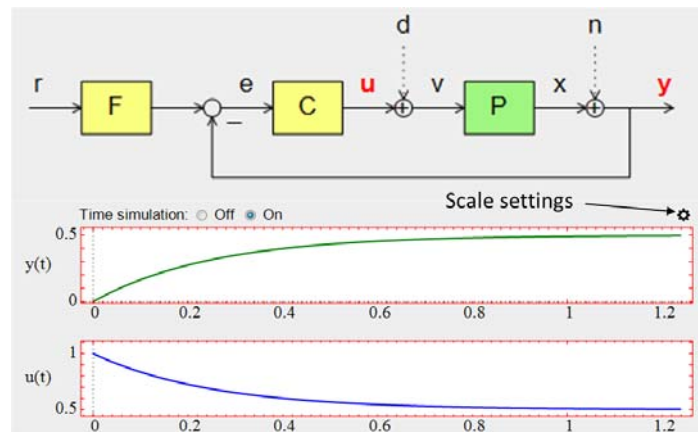

Figure 19. Auxiliary window to configure different options of the *frequency response* zone: a) Bode diagram, b) Polar diagram and Nichols diagram.

9. Time response

The *time response* zone is located in the right lower corner of the LCSD main window (see Figure 1). Up to two signals (r , e , u , d , v , x , n and y) can be plotted in this zone. The signals are plotted in solid line. If a controller has been loaded to compare (see Section 12), then the signals associated to the loaded controller are plotted in dashed lines. In this zone, time specifications can also be plotted (see section 11) as a combination of yellow rectangles that establishes forbidden regions for y or u .

The user can choose the signals to display. In the *block diagram* zone, the user must click on the label associated to the signal (r , e , u , d , v , x , n and y) that he wants visualise. If a signal is selected to display, then its label is in red colour (see Figure 20). Otherwise, its label is in black colour.



(a)

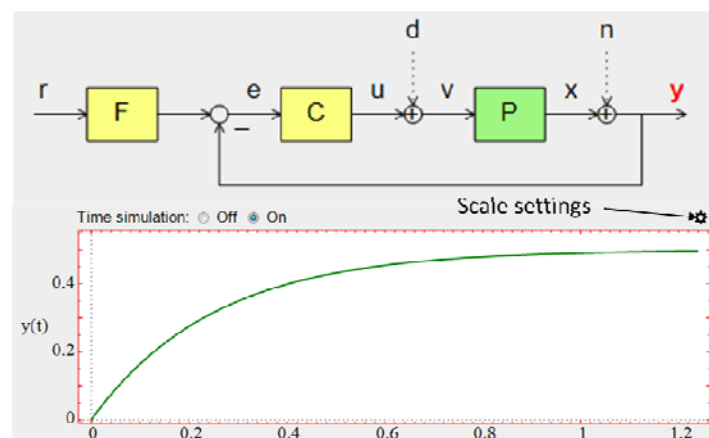

(b)

Figure 20. Relation between the *block diagram* zone and *time response* zone : a) Two signals are selected. b) One signal is selected.

When the user finishes a dragged operation, LCSD updates the information in all the zones of the main window. If the time simulation takes a long time, in order to short the update, the user should disable the time simulation. To do this action, the user has to click on the radiobutton *Off* located in the right upper part of the *time response* zone. If the user wants to enable the time simulation, he/she has to click on the radiobutton *On*.

By default, the simulation is done in closed-loop. To open or close the loop, the user has to click on the feedback loop line in the *block diagram* zone (see Figure 21). If the feedback loop is closed, then the loop line is drawn in solid line, otherwise the loop line is drawn in dotted line.

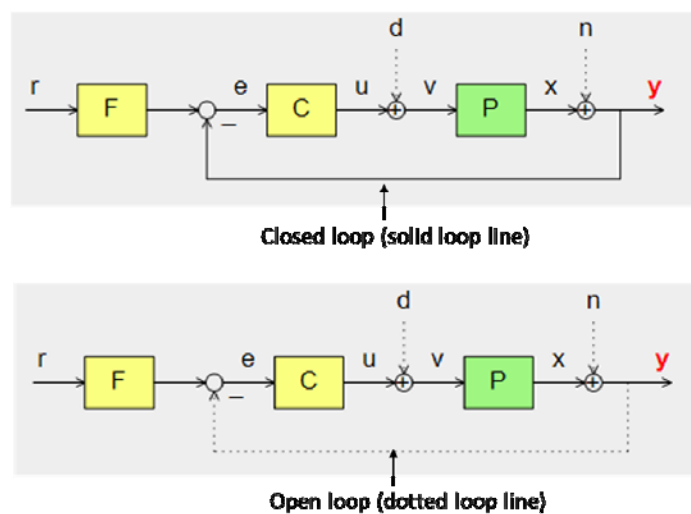

Figure 21. The user has to click on the loop line in the *block diagram* zone to open or close the feedback loop

On the other hand, to configure the scale of the *time response* zone, the user has to click on the gearwheel icon located in the right upper corner of the zone (see Figure 20). When the user does this action, an auxiliary window is shown (see Figure 22). There are two types of scale:

- *Locked* scale. The axes limits are set by the user in the textfields and sliders of the auxiliary window.
- *Variable* scale. The axes limits are set automatically by LCSD to be able to visualize all the poles and zeros.

The user can select the type of scale by clicking on the corresponding radiobutton: *locked* or *variable*. Besides, in this auxiliary window, the user can choose whether or not

to show the time responses points. In affirmative case, if the user locates the mouse pointer on a point, its coordinates are displayed.

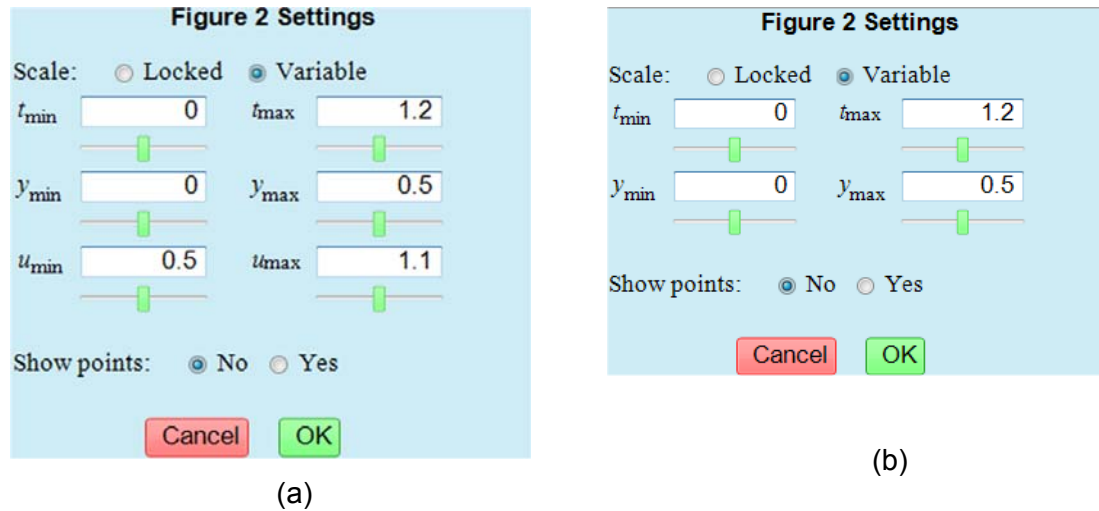

Figure 22. Auxiliary window to configure the scale in the *time response* zone:

a) Two signals (u and y) are plotted. b) One signal (y) is plotted.

10. Frequency performance/specifications

The *performance/specifications* zone is located in the left central part of the LCSD main window (see Figure 1). Figure 23 shows the appearance of this zone when there are not specifications enabled. In this case, the buttons *Frequency specifications* and *Time Specifications* are in yellow colour. Besides, there is a table with frequency and time characteristics. In the left part of this table, the value of the following frequency characteristics [Ogata, 2009] of the open loop transfer function $L(s) = P(s) \cdot C(s)$ are shown:

- Gain margin g_m . It is the factor g_m by which the gain must be changed in order to produce instability

$$g_m = \frac{1}{|G(j\omega_{pc})|} \quad (1)$$

- Phase crossover frequency ω_{pc} . This is the frequency at which the phase of the transfer function is -180°

- Phase margin φ_m . It is the amount of phase shift at the gain crossover frequency ω_{gc} that would just produce instability. It is defined as 180° plus the phase angle at ω_{gc} :

$$\varphi_m = 180^\circ + \arg L(j\omega_{gc}) \quad (2)$$

- Gain crossover frequency ω_{gc} . This is the frequency at which the magnitude of the transfer function is the unity.

If there is some enabled specification, then this table is hidden. To display the table with the time and frequency characteristics, the user has to type the key {e}. To hide this table and see the enabled specifications, the user has to type again the key {e}.

| Freq. Specifications | | | Time Specifications | | |
|-----------------------|----------------------|---------|-----------------------|-------|-----------|
| <input type="radio"/> | ξ_m | --- Inf | <input type="radio"/> | P_O | --- 0 |
| <input type="radio"/> | $\omega_{\varphi c}$ | --- NaN | <input type="radio"/> | t_r | --- 0.55 |
| <input type="radio"/> | φ_m | --- Inf | <input type="radio"/> | t_s | --- 0.98 |
| <input type="radio"/> | ω_{gc} | --- NaN | <input type="radio"/> | e_s | --- 50.00 |
| | | | <input type="radio"/> | K_p | --- 1.00 |

Figure 23. Appearance of the *performance/specifications* zone when there are not specifications. In this case, a table of frequency and time characteristics is shown.

LCSD implements seven frequency specifications (see Table 1). To enable or disable a certain specification, the user has to do the following steps:

1. Click on the button *Frequency specifications*. An auxiliary window (see Figure 24) is shown on the screen. Note that the specifications that appears in the auxiliary window depends on the selected frequency response diagram: Bode, polar or Nichols (see Table 1).
2. Click on the checkmarks associated to the specifications that you want to enable or disable.
3. Click on OK.

| Frequency specification | Of | Bode | Polar | Nichols |
|--|------|------|-------|---------|
| Low frequency disturbances attenuation LF | L(s) | Yes | No | No |
| High frequency disturbances attenuation HF | L(s) | Yes | No | No |
| Gain margin g_m | L(s) | Yes | Yes | Yes |
| Phase margin φ_m | L(s) | Yes | Yes | Yes |
| Gain crossover frequency ω_{gc} | L(s) | Yes | No | No |
| Maximum sensitivity M_s | S(s) | No | Yes | Yes |
| Maximum complementary sensitivity M_T | T(s) | No | Yes | Yes |

Table 1. Frequency specifications implemented in LCSD

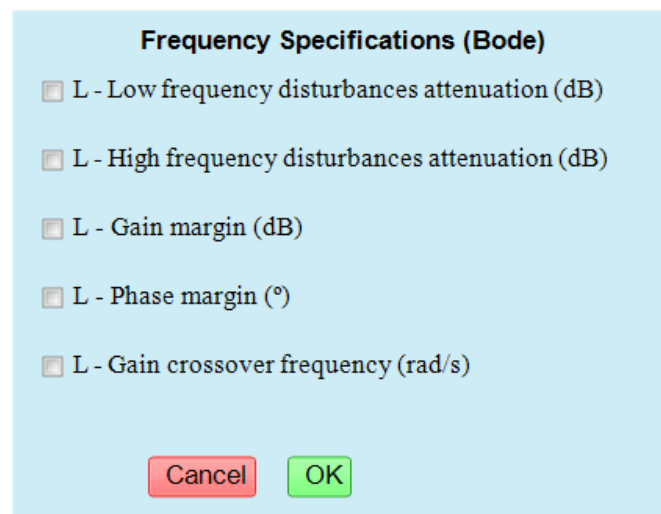

Figure 24. Auxiliary window to configure the frequency specifications on the Bode plot. In this example, the specification LF is enabled

When there are frequency enabled specifications, the *performance/specifications* zone changes the appearance, and it only shows information about the enabled specifications (see Figure 25). For each enabled specification, the following information is displayed:

- Circular indicator. The green colour means the specification is fulfilled. Otherwise (red colour), the specification is not fulfilled.

- Specifications symbol (see Table 1). If the user places the pointer mouse on this symbol, a text shows the meaning of the symbol.
- Specification value. The green colour means the specification is fulfilled. Otherwise (red colour), the specification is not fulfilled.
- System value for this characteristic. This value can be a real number or infinite (Inf). If the value doesn't exist, then the symbol NaN is shown. If LCSD cannot compute automatically the value or the Time Simulation is off, then the value -1 is shown.

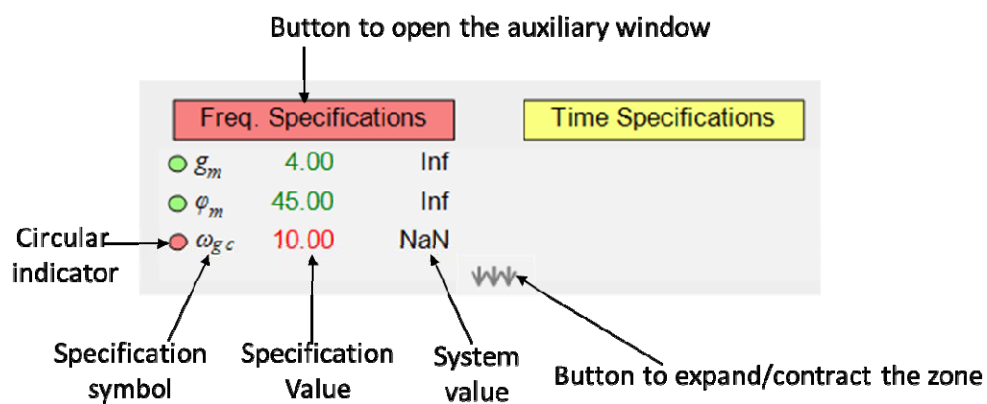

Figure 25. Possible aspect of the *performance/specifications* zone when there are enabled frequency specifications

In addition, the button *Frequency Specifications* is in red or green colour. The red colour means that some frequency specification is not fulfilled. On the contrary, Green colour means that all the frequency specifications are fulfilled.

If the number of enabled frequency specifications is greater than four, then a button is shown in the central bottom part of the *performance/specifications* zone. It allows the user to contract or expand the zone to see all the enabled specifications.

To set the value of a enabled specification, the user has to do the following steps:

1. Click on the button *Frequency specifications*. When the user executes this action, an auxiliary window (see Figure 24) is show on the screen.

2. Write the value in the text field below the specification. Besides, some specifications can be set dragging some interactive element associated to this specification in the *frequency response* zone.
3. Click on OK.

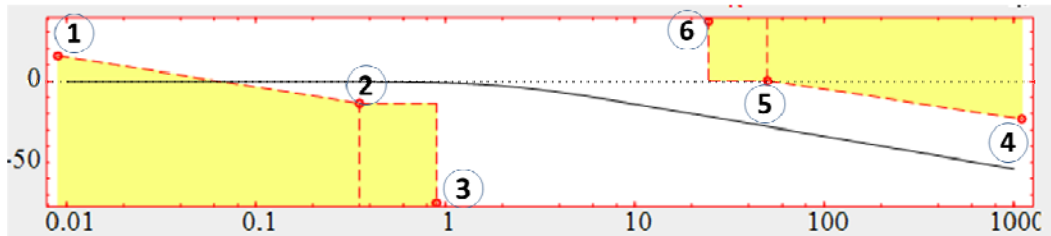

Figure 26. Interactive elements (red points) to set the specifications *LF* and *HF*

The specifications *Low frequency disturbances attenuation LF* and *High frequency disturbances attenuation HF* define forbidden (yellow) areas where $L(s)$ does not have to pass. In the case of specification *LF*, the user has to configure four textfields, or drag the corresponding interactive elements in the bode magnitude plot (see Figure 26). To set:

- Slope s_l . Drag vertically upward or downward the interactive element 1.
- Magnitude m_l (dB) Drag vertically upward or downward the interactive element 2.
- Frequency ω_{l1} Drag horizontally to left or right the interactive element 2.
- Frequency ω_{l2} Drag horizontally to left or right the interactive element 3.

For the specification *HF*, the user has to configure four textfields, or drag the corresponding interactive elements in the bode magnitude plot (see Figure 26). To set:

- Slope s_h . Drag vertically upward or downward the interactive element 4.
- Magnitude m_h (dB). Drag vertically upward or downward the interactive element 5.
- Frequency ω_{h1} Drag horizontally to left or right the interactive element 5.
- Frequency ω_{h2} Drag horizontally to left or right the interactive element 6.

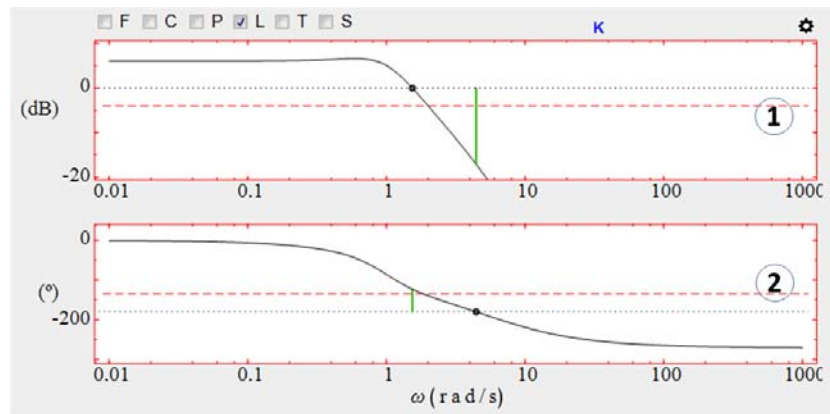

(a)

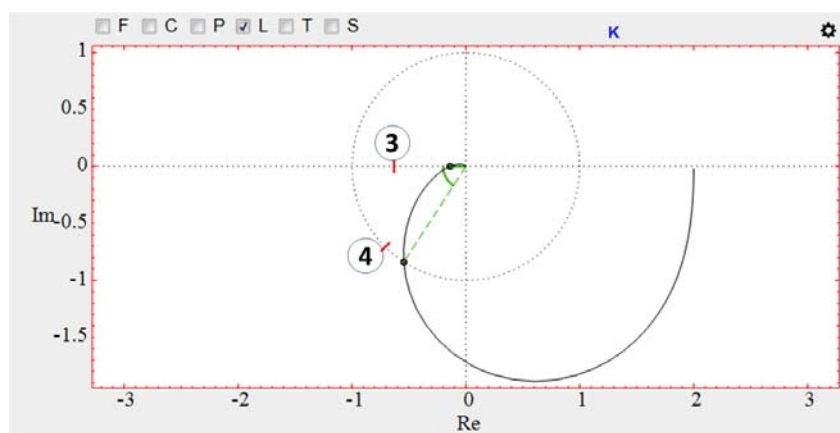

(b)

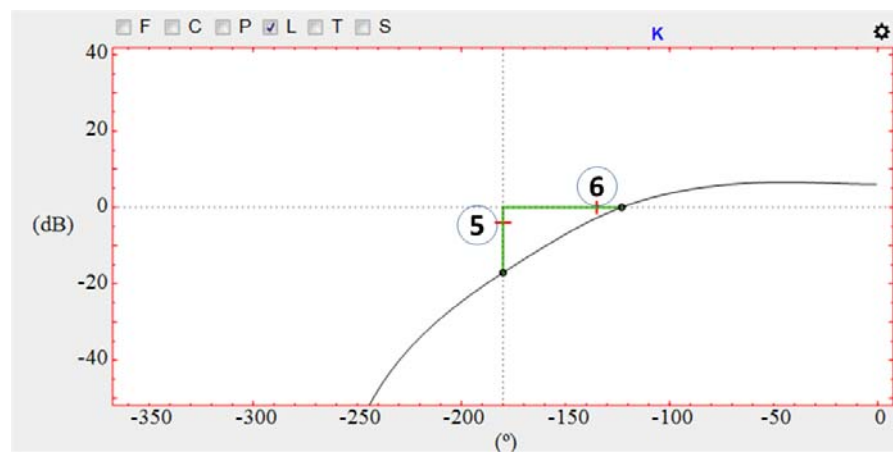

(c)

Figure 27. Interactive elements to set the specifications of *gain margin* and *phase margin* in: a) bode diagram. b) polar diagram. c) nichols diagram

For the specification *gain margin* g_m , the user has to configure a textfield, or drag the corresponding interactive element in the following diagram (see Figure 27). To set:

- Bode magnitude diagram. Drag vertically upward or downward the dotted red line 1.
- Polar diagram. Drag horizontally to left or right the red segment 3.
- Nichols diagram. Drag vertically upward or downward the red segment 5.

Note that if the specification is fulfilled, the gain margin is represented in green. Otherwise, it is represented in red.

For the specification *phase margin* φ_m , the user has to configure a textfield, or drag the corresponding interactive element in the following diagram (see Figure 27). To set:

- Bode magnitude diagram. Drag vertically upward or downward the dotted red line 2.
- Polar diagram. Drag on the unit circle the red segment 4.
- Nichols diagram. Drag horizontally to left or right the red segment 6.

Note that if the specification is fulfilled, then phase margin is represented in green. Otherwise, it is represented in red.

In the case of the specification *gain crossover frequency* ω_{gc} , the user has to set a textfield, or drag the interactive element 1 (see Figure 28) horizontally to left or right. Note that if the specification fulfilled, then segment is represented in green. Otherwise, it is represented in red.

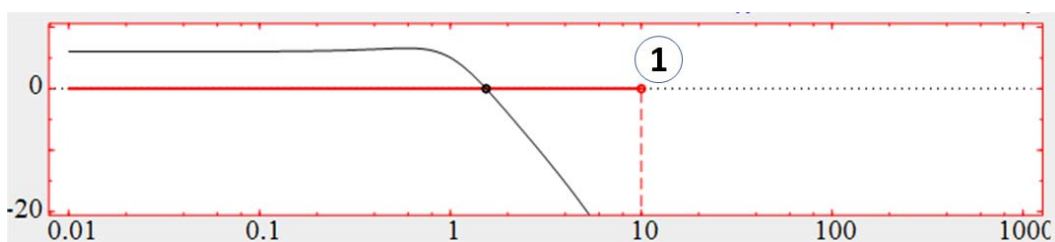

Figure 28. Interactive element (red point) to set the specifications *gain crossover frequency* ω_{gc}

The specifications *Maximum sensitivity* M_s and *Maximum complementary sensitivity* M_T

$$\left| \frac{1}{1+L(s)} \right| \leq M_s \tag{3}$$

$$\left| \frac{L(s)}{1+L(s)} \right| \leq M_T \tag{4}$$

define forbidden (yellow) areas (see Figures 29 and 30) where $L(s)$ does not have to pass. These specifications can set by textfields, or dragging upward or downward the contour of the yellow areas. In the polar diagram, M_s and M_T are specified in arithmetic units, while in the Nichols plot they are specified in decibels (dB).

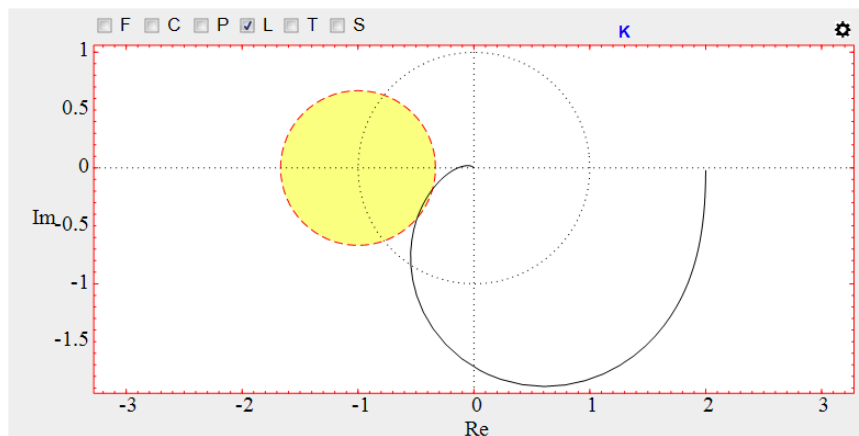

(a)

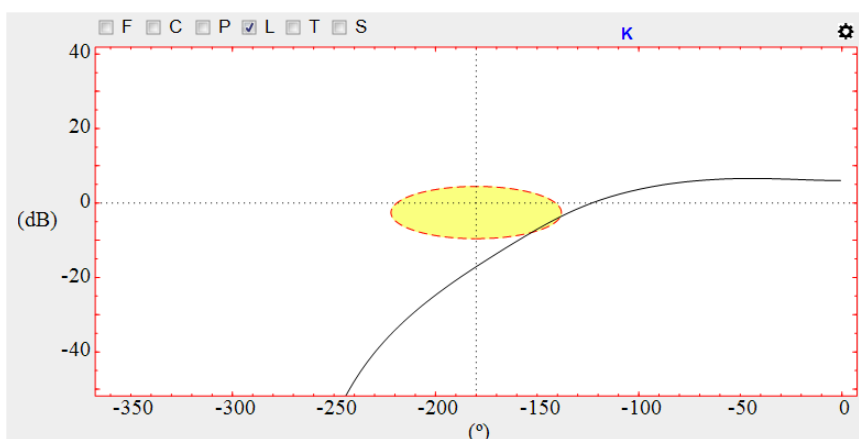

(b)

Figure 29. Specification *Maximum sensitivity* M_s : a) Polar diagram. b) Nichols diagram

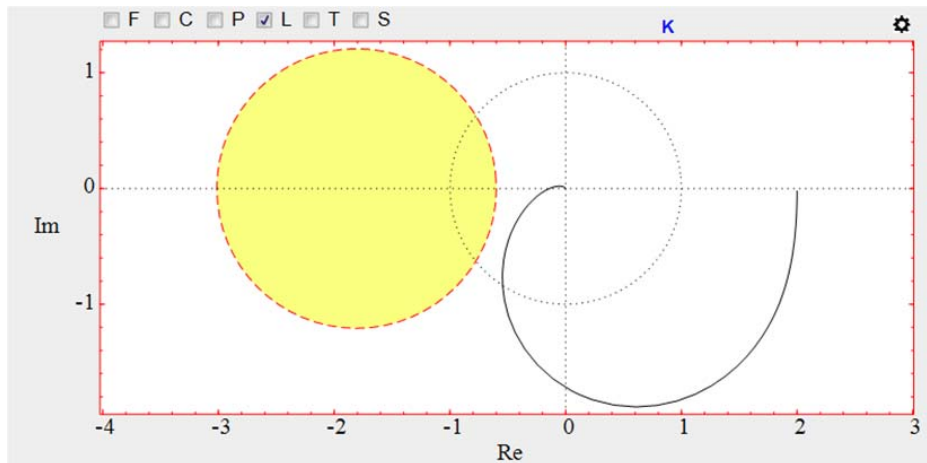

(a)

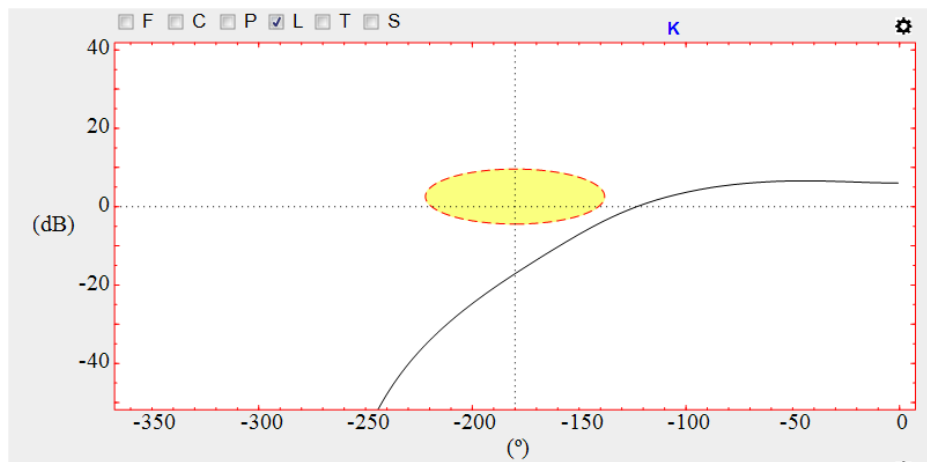

(b)

Figure 30. Specification *Maximum complementary sensitivity* M_s : a) Polar diagram. b) Nichols diagram

11. Time performance/specifications

The *performance/specifications* zone is located in the left central part of the LCSD main window (see Figure 1). Figure 23 shows the appearance of this zone when there are not specifications selected. In this case, the buttons *Frequency specifications* and *Time Specifications* is in yellow colour. Besides, there is a table with frequency and time characteristics. In the right part of this zone, the following parameters of the system step response y [Ogata, 2009] are shown:

- Maximum overshoot percentage P_o . It is the maximum peak value of the response curve measured from unity in percentage. If the closed loop system is unstable, the value NaN is shown in the table.
- Rise time t_r . It is the time required for the response to go from 10% to 90% of its final value. If the closed loop system is unstable, the value NaN is shown in the table.
- Settling time t_s . It is the time required for the response curve to reach and thereafter remain within a 2% percentage of its final value. If LCSD cannot compute automatically t_s , then the value -1 is shown in the table. In this case, the user has to increase the simulation time t_{\max} in the auxiliary window of the *time response* zone (see Figure 22). If the closed loop system is unstable, the value NaN is shown in the table.

Besides, the steady-state error e_s [Ogata, 2009] in closed loop is shown:

$$e_s = 100 \cdot \lim_{t \rightarrow \infty} e(t) = 100 \cdot \lim_{s \rightarrow 0} sE(s) = 100 \cdot \lim_{s \rightarrow 0} s \frac{sR(s)}{1 + L(s)} \quad (5)$$

Depending on the type of the plant, the static position error constant K_p , the static velocity error constant K_v , the static acceleration error constant K_a , or the static error constant K_n is also shown:

$$K_p = \lim_{s \rightarrow 0} L(s) \quad (6)$$

$$K_v = \lim_{s \rightarrow 0} sL(s) \quad (7)$$

$$K_a = \lim_{s \rightarrow 0} s^2L(s) \quad (8)$$

$$K_n = \lim_{s \rightarrow 0} s^{n-1}L(s) \quad (9)$$

If there is some enabled specification this table is hidden. To show the table with the time and frequency characteristics, the user has to type the key {e}. To hide this table and see the enabled specifications, the user has to type again the key {e}.

LCSD implements nine time specifications (see Table 2). To enable or disable a certain specification, the user has to do the following steps:

1. Click on the button *Time specifications*. When the user does this action, an auxiliary window (see Figure 31) is show on the screen.
2. Click on the checkmarks associated to the specifications that you want to enable or disable.
3. Click on OK.

| Time specification | Zone where is drawn |
|--|----------------------------|
| Maximum overshoot percentage P_o | Time response |
| Maximum rise time t_r | Time response |
| Maximum settling time t_s | Time response |
| Maximum steady-state error percentage e_s Maximum static error constant K_n | None |
| Minimum absolute damping σ | Root locus |
| Minimum relative damping δ | Root locus |
| Dominant poles d_p | Root locus |
| Maximum control signal u_h | Time response |
| Minimum control signal u_l | Time response |

Table 2. Time specifications implemented in LCSD

Time Specifications

Maximum overshoot %
 P_O

Maximum rise time
 t_r

Maximum settling time
 t_s

Maximum steady-state error (step input) %

Minimum absolute damping

Minimum relative damping

Dominant poles

Maximum control signal

Minimum control signal

Figure 31. Auxiliary window to configure the time specifications

When there are enabled time specifications, the *performance/specifications* zone changes its appearance, and it only shows information about the enable specifications (see [Section 10](#)).

To set the value of a enabled specification, the user has to do the following steps:

1. Click on the button *Time specifications*. When the user does this action, an auxiliary window (see Figure 31) is show on the screen.
2. Write the value in the text field below the specification. Besides, some specifications can be set dragging some interactive element associated to this specification in the *time response* zone.
3. Click on OK.

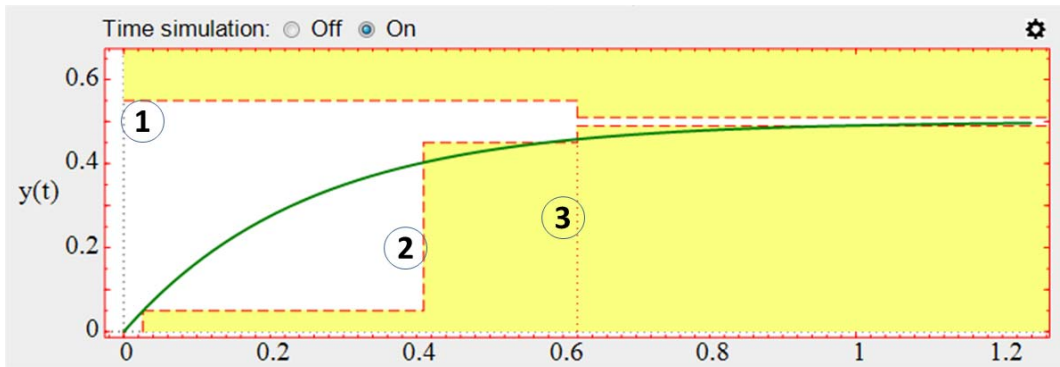

Figure 32. Interactive elements to set the specifications P_o , t_r , and t_s

The specifications *maximum percentage overshoot* P_o , *maximum rise time* t_r , and *maximum settling time* t_s define forbidden (yellow) areas where $y(t)$ does not have to pass. These three specifications can be set by textfields or by dragging the corresponding interactive element (see Figure 32):

- To set P_o , the user has to drag vertically the red dotted horizontal line 1.
- To set t_r , the user has to drag horizontally the red dotted vertical line 2.
- To set t_s , the user has to drag horizontally the red dotted vertical line 3.

The specifications *minimum absolute damping* σ , *minimum relative damping* δ , and *dominant poles* can be set in the *root locus zone* (see Section 7). When the specification *dominant poles* is enabled, the following information associated to this specification is shown in the *performance/specifications zone* (see Figure 33). If the system has not a pair of dominant complex poles, then NaN is shown.

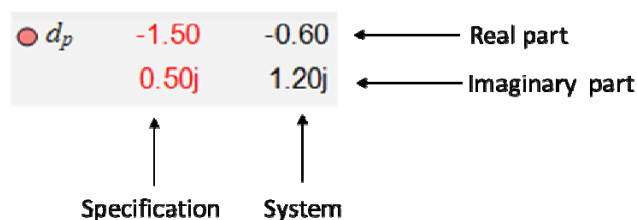

Figure 33. Information about the dominant *poles specification* in the *performance/specifications zone*

The specifications *maximum control signal* u_h , and *minimum control signal* u_l define forbidden (yellow) areas where $u(t)$ does not have to pass. These two specifications can be set by textfields or by dragging the corresponding interactive element (see Figure 34):

- To set u_h , the user has to drag vertically the red dotted horizontal line 1.
- To set u_l , the user has to drag vertically the red dotted vertical line 2.

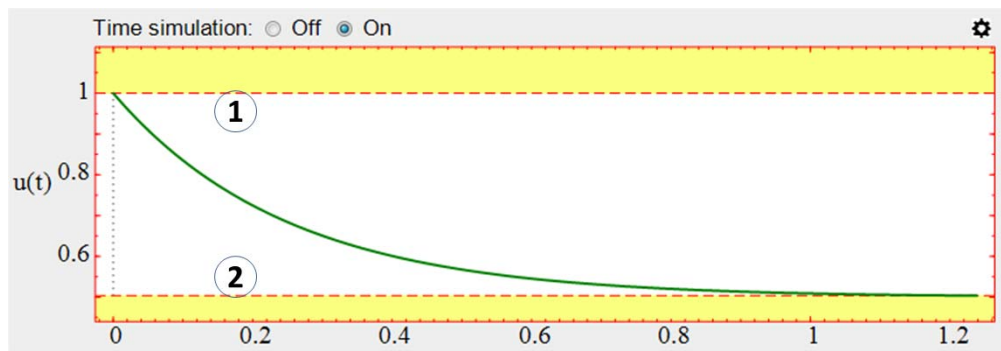

Figure 34. Interactive elements to set the specifications u_h and u_l

12. Save, Load and compare controllers

LCSD allows saving the current controller C and prefilter F in a text file. To do that, the user has to click on the menu entry *Control/Save control*, a dialog box is shown in the screen where user must write the file name. By default, the file name has the following structure:

```
control_LCSD_[year]_[month]_[day]_[time].txt
```

For example: `control_LCSD_2017_2_7_101955.txt`.

LCSD also allows replacing the current C and F for a controller and prefilter previously saved in a text file. To load a control file, the user has to click on the menu entry *Control/Load control*, a dialog box is shown in the screen where user must write the name of the control file that he wants to load.

Besides, the tool allows loading a control file to compare with the current control. The magnitudes associated to the loaded control are plotted in dashed line. To do that, the user has to click on the menu entry *Control/Load control to compare*, and write the name

of the control file that he wants to load. To finish the comparison, the user has to click on the menu entry *Control/Remove control to compare*.

13. Save and load a work session

A *work session* refers to the state of LCSD in a certain time T. Such state is defined by the values of the data and variables used by LCSD in T.

LCSD allows saving a work session. To do that, the user has to type the key {s}, or click on the menu entry *Session/Save session*. When the user executes some of these actions, a dialog box is shown in the screen where he/she must write the name of the work session file that he wants to save. By default, the file name has the following structure:

LCSD_[year]_[month]_[day]_[time].dat

For example: LCSD_2017_2_7_101955.dat

To load a work session, the user has to type the key {l}, or click on the menu entry *Session/Load session*. When the user executes some of these actions, a dialog box is shown in the screen where he/she must write the name of the work session file that he wants to load.

14. Save a report

LCSD allows saving a *report* file with the following data: *P*, *C*, *F*, time and frequency specifications, and system performance. To generate a report, the user has to type the key {a}, or click on the menu entry *Session/Save report*. When the user executes some of these actions, a dialog box is shown in the screen where he/she must write the name of the report file. By default, the file name has the following structure:

LCSD_report_[year]_[month]_[day]_[time].html

For example: LCSD_report_2017_2_7_101955.html. Note that the work session is also saved with the same name of the report.

15. Menu options

In the upper part of the LCSD main window, there are five menus (see Figure 1): *Session*, *Control*, *Options*, *Info*, and *Help*.

The menu *Session* has four entries:

- *Load session*. The shortcut for this menu entry is the key {l}. See section 13.
- *Save session*. The shortcut for this menu entry is the key {s}. See section 13
- *Save report*. The shortcut for this menu entry is the key {a}. See section 14.
- *Reset*. When the user clicks on this menu entry, LCSD recovers its startup values.

The menu *Control* has four entries:

- *Load control*. See section 12.
- *Save control*. See section 12.
- *Load control to compare*. See section 12.
- *Remove control to compare*. See section 12.

The menu *Options* has three entries:

- *Frequency range for validation*. LCSD allows setting the following parameters to do the frequency validation: number of points N , lower frequency 10^{d_1} , and higher frequency 10^{d_2} . When the user clicks on this menu, a dialog box is shown in the screen where user must write N , d_1 , and d_2 . By default, $N = 1000$, $d_1 = -3$, $d_2 = 3$.
- *Internal derivative filter for ideal PID*. LCSD uses internally the derivative filter $\frac{T_d s}{\alpha T_d s + 1}$ for the time simulation of an ideal PID. User can select the value of α in the range [0.001, 0.8]. By default, $\alpha = 0.1$.

- *Time simulation settings.* LCSD allows the user to set four parameters of the Sysquake ordinary differential equations (odes) solvers that are used for the time simulation:
 - *Maximum absolute error* 10^{-d} ($d= 3, 4, 5, \text{ or } 6$). By default, it is set to 10^{-4} .
 - *Maximum relative error* 10^{-d} ($d= 1, 2, 3, \text{ or } 4$). By default, it is set to 10^{-3} .
 - *Refinement factor ode23s.* It is the refinement factor that is used for the solver of stiff systems of Sysquake, the function `ode23s`. This factor specifies how many points are added to the result for each integration step. When it is larger than 1, additional points are interpolated. By default, this parameter is set to 1. To display the effect of this parameter, click on the gearwheel icon located in the right upper corner of the zone Time Response (see Figure 20). When the user does this action, an auxiliary window is shown (see Figure 22). Select Yes in the option Show Points.
 - *Refinement factor ode45.* It is the refinement factor that is used for the solver of non-stiff systems of Sysquake, the function `ode45`. This factor specifies how many points are added to the result for each integration step. When it is larger than 1, additional points are interpolated. By default, this parameter is set to 4. To display the effect of this parameter, click on the gearwheel icon located in the right upper corner of the zone Time Response (see Figure 20). When the user does this action, an auxiliary window is shown (see Figure 22). Select Yes in the option Show Points.

A low value for the maximum absolute or relative error increases the computation time. A high value for the refinement factor also increases the computation time.

The menu *Info* has two options:

- *About*. When the user clicks on this menu, a dialog box is shown with information about the number version and authors.
- *Help*. When the user clicks on this menu, the LCSD web page is opened in a default computer browser.

Finally, the menu *Help* has the option *About This Application...* that shows a dialog box with the Sysquake logo, to remind that this application has been developed in Sysquake [Piguet, 2017].

APPENDIX A. Colour code

| Transfer function | Colour |
|----------------------------------|---------------|
| Plant $P(s)$ | Red |
| Controller $C(s)$ | Blue |
| Prefilter $F(s)$ | Blue |
| Open loop $L(s)$ | Black |
| Complementary sensitivity $T(s)$ | Green |
| Sensitivity $S(s)$ | Grey |
| $F(s) \cdot T(s)$ | <i>Black</i> |

Table 3. Colour code

APPENDIX B. Keyboard shortcuts

| Key | Meaning |
|------------|--|
| 1 | Show the root locus/frequency response to small size |
| 2 | Show root locus/the frequency response to medium size |
| 3 | Show the root locus/frequency response to large size |
| e | Show or hide the table of time and frequency characteristics |
| l | Load session |
| s | Save session |
| a | Generate report |
| b | Show bode diagram |
| p | Show polar diagram |
| n | Show nichols diagram |
| r | Show root locus diagram |
| v | Set the scale to variable type in all the figures |
| k | Set the scale to locked type in all the figures |

Table 4. Keyboard shortcuts

BIBLIOGRAPHY

- [Dorf and Bishop , 2010] R. C. Dorf and R. H. Bishop. Modern Control Systems. Pearson. 12th Edition. 2010.
- [Ogata, 2009] K. Ogata. Modern Control Engineering. Pearson. 5th Edition. 2009.
- [Piguet, 2017] Y. Piguet. Sysquake Pro 6.0 User Manual. Calerga Sarl. www.calerga.com. 2017.

