

ITCLSD USER GUIDE

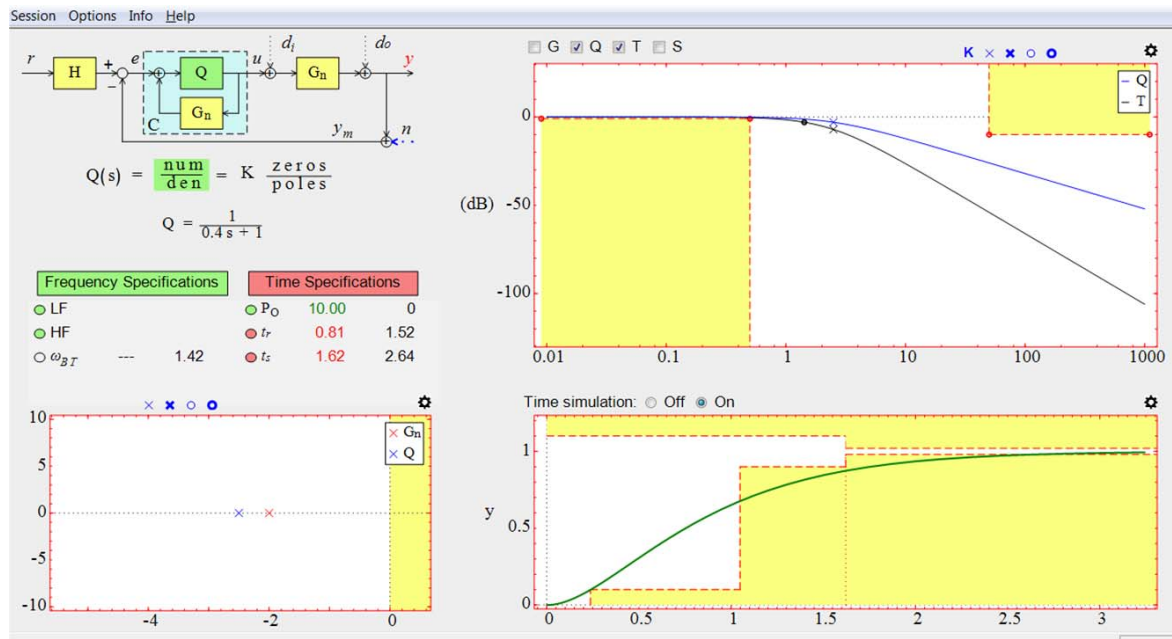

José Manuel Díaz Martínez
Ramón Costa Castelló
Sebastián Dormido Bencomo



December 11, 2018

ITCLSD User Guide. 2018.

Copyright © 2018 José Manuel Díaz Martínez, Ramón Costa Castelló and Sebastián Dormido Bencomo.

All rights reserved. No part of this guide may be copied or reproduced without the permission in writing of the authors.

Departamento de Informática y Automática

E.T.S.I Informática.

Universidad de Educación a Distancia (UNED).

C/ Juan del Rosal nº 16. Madrid 28040 (España)

INDEX

1. About ITCLSD	1
2. A brief introduction to the closed loop shaping control design methodology	1
3. Plant configuration	5
4. Controller configuration	11
5. Prefilter configuration	14
6. Inputs configuration	15
7. Poles-zeros map	17
8. Frequency response	19
9. Time response	23
10. Frequency performance/specifications	25
11. Time performance/specifications	43
12. Save and load a work session	46
13. Save a report	47
14. Menu options	47
Appendix A: Colour code	50
Appendix B: Keyboard shortcuts	50
Bibliography	51

1. About ITCLSD

ITCLSD is an Interactive software Tool for Closed Loop Shaping control Design. It has been developed with Sysquake 6.0 [Piguet, 2017] by José Manuel Díaz Martínez (UNED), Ramón Costa Castelló (UPC), and Sebastián Dormido Bencomo (UNED). It can be downloaded for Windows and Mac platforms from the following link:

<http://www2.uned.es/itfe/ITCLSD/ITCLSD.html>

2. A brief introduction to the closed loop shaping control design methodology

Figure 1 shows the block diagram of a basic feedback control system with two degrees of freedom [Åström and Murray, 2008], [Goodwin et al., 2001], [Skogestad and Postlethwaite, 2005]. Where $G(s)$ is the plant, $C(s)$ is the feedback controller, and $H(s)$ is the reference prefilter. The external signals are the reference signal r , the plant input disturbance d_i , the plant output disturbance d_o , and the measurement noise n . The process output is y . However, due to n , the measured process output is y_m . The control input is e , and its output or control signal is u .

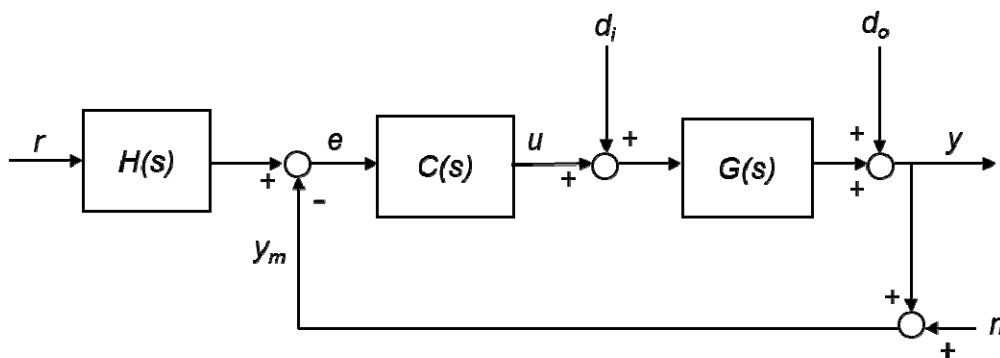

Figure 1. Block diagram of a basic feedback control system with two degrees of freedom

The closed loop response y can be written as:

$$y(s) = \frac{G(s)C(s)H(s)}{1+G(s)C(s)}r + \frac{G(s)}{1+G(s)C(s)}d_i(s) + \frac{1}{1+G(s)C(s)}d_o(s) - \frac{G(s)C(s)}{1+G(s)C(s)}n(s). \quad (1)$$

Or equivalently:

$$y(s) = H(s)T(s)r(s) + G(s)S(s)d_i(s) + S(s)d_o(s) - T(s)n(s), \quad (2)$$

where

$$T(s) = \frac{G(s)C(s)}{1 + G(s)C(s)}, \quad (3)$$

is the complementary sensitivity function, and

$$S(s) = \frac{1}{1 + G(s)C(s)}, \quad (4)$$

is the sensitivity function.

It is important to note that $T(s)$ and $S(s)$ are algebraically related by the expression

$$T(s) + S(s) = 1. \quad (5)$$

The control error is defined as

$$\varepsilon = r - y. \quad (6)$$

It can be expressed as function of the sensitivity functions:

$$\varepsilon(s) = (1 - H(s)T(s))r(s) + G(s)S(s)d_i(s) + S(s)d_o(s) - T(s)n(s) \quad (7)$$

In a perfect control system ε should be 0, that is,

$$\varepsilon \approx 0 \cdot r + 0 \cdot d_i + 0 \cdot d_o + 0 \cdot n \quad (8)$$

This requirement can be decomposed in the following goals [Åström and Murray, 2008], [Skogestad and Postlethwaite, 2005]:

- Tracking the reference signal r . To achieve this goal $T \approx 1$ and $S \approx 0$.
- Rejecting disturbances d_i and d_o . This goal requires $S \approx 0$ and $T \approx 1$.
- Trying to be as much insensible as possible to the measurement noise n . This goal can be achieved if $T \approx 0$ and $S \approx 1$.

It can be observed that the requirements of the third goal are opposite to the previous two. Fortunately, these goals are generally in different frequency ranges. In most common applications, the reference and the plant disturbances are constant or slow varying signals with frequencies in the range $[0, \omega_l)$, while the measurement noise is a fast varying signal with frequencies in the range $[\omega_h, \infty)$. Therefore, the requirements for the functions T and S can be reformulated in function of the frequency band:

- *Low frequency or control band*, $\omega \in [0, \omega_l)$. The reference must be tracked and the plant disturbances must be rejected in this frequency band. These goals require that $T(j\omega) \approx 1$ and $S(j\omega) \approx 0$.
- *High frequency or cut-off band*, $\omega \in [\omega_h, \infty)$. The noise must not be amplified in this frequency band. Consequently, $T(j\omega) \approx 0$ and $S(j\omega) \approx 1$.
- *Mid frequency or crossover band*, $\omega \in [\omega_l, \omega_h)$. This is a transition region between low frequency and high frequency. There are not specific performance specifications in this frequency band. Robustness margins are usually defined in it.

In order to fulfil these requirements for the functions $T(s)$ and $S(s)$ in the three frequency bands, an adequate controller $C(s)$ must be designed.

The design method known as *closed loop shaping* directly shape the closed loop transfer functions $T(s)$ or $S(s)$ ([Åström and Murray, 2008], [Goodwin et al., 2001], [Skogestad and Postlethwaite, 2005]). Equations (3) and (4) shows that $T(s)$ or $S(s)$ are nonlinear functions of the controller $C(s)$. This makes difficult to tune the controller to achieve desired closed loop properties. Fortunately, using the *affine parameterization* (as known as *Youla parameterization*) [Åström and Murray, 2008], [Goodwin et al., 2001], and supposed that the plant is stable, the controller can be expressed as

$$C(s) = \frac{Q(s)}{1 - Q(s)G_n(s)}, \quad (9)$$

Where $G_n(s)$ is the nominal plant (note that if the plant $G(s)$ has no uncertainty, then $G_n(s) = G(s)$), and $Q(s)$ is a stable proper transfer function (see Figure 2) that has to be designed.

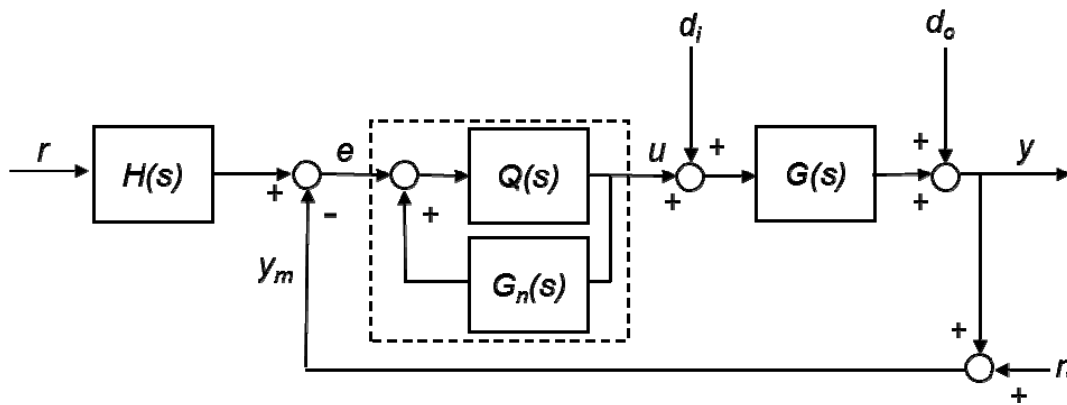

Figure 2. Block diagram of a basic feedback control system with two degrees of freedom using affine parametrization

By using (9), $T(s)$ and $S(s)$ can be written as

$$T(s) = Q(s)G(s), \quad (10)$$

$$S(s) = 1 - Q(s)G(s). \quad (11)$$

The affine parameterization describes all possible stabilizing linear time-invariant controllers for the given linear time-invariant plant $G(s)$. As $Q(s)$ and $G(s)$ are stable, the closed loop stability is guaranteed by construction. Note that with this parameterization, the poles of the closed transfer function $T(s)$ and $S(s)$ are the poles of $G(s)$ and $Q(s)$. Besides, the zeros of $T(s)$ are the zeros of $G(s)$ and $Q(s)$. Thus, the desired shape of $T(s)$ could be directly obtained adding or removing, and modifying the elements (poles, zeros or gain) of the filter $Q(s)$.

Design $Q(s)$ to directly obtain a desired shape of $S(s)$ is more complicated, because the zeros of $S(s)$ depends on the poles and zeros of $G(s)$ and $Q(s)$.

Remind that $T(s)$ and $S(s)$ are related by (5) and cannot be independently fixed. Once one is specified, the other is determined. Therefore, the designer has to select which sensitivity function wants to specify, $T(s)$ or $S(s)$.

To perform a closed loop shaping control design using ITCLSD, the user must follow the following steps:

1. Define the plant $G_n(s)$.
2. Select the closed loop function that he/she wants to design $T(s)$ or $S(s)$.
3. Configure the problem specifications in the frequency domain and/or time domain.
4. Select the structure of the filter $Q(s)$.
5. Select the frequency diagram (Bode, polar, or Nichols) where the closed loop shaping design is going to be performed.
6. Drag the gain or the frequency corners of the $Q(s)$ (or $F_Q(s)$) poles and zeros to modify the shape of the closed loop function to meet the specifications. The user can see immediately what specifications are met because ITCLSD validates the specifications each time the user modifies the gain or a corner frequency. In the main window, there are circular indicators associated to each specification. If an indicator is in green colour that means its associated specification is met, otherwise the indicator is in red colour.

3. Plant configuration

To select the plant structure, the user has to double click on the block G_n of the *block diagram* zone, which is located at the left upper corner of the main window (see Figure 3). When the user performs this action, an auxiliary window is shown in the screen (see Figure 4) with all the available plant structures. ITCLSD has thirteen plant structures: twelve predefined (rows 1 to 3) and one user-defined (row 4). The user has to click on the desired structure (the block takes a light green colour), and pulse the button OK.

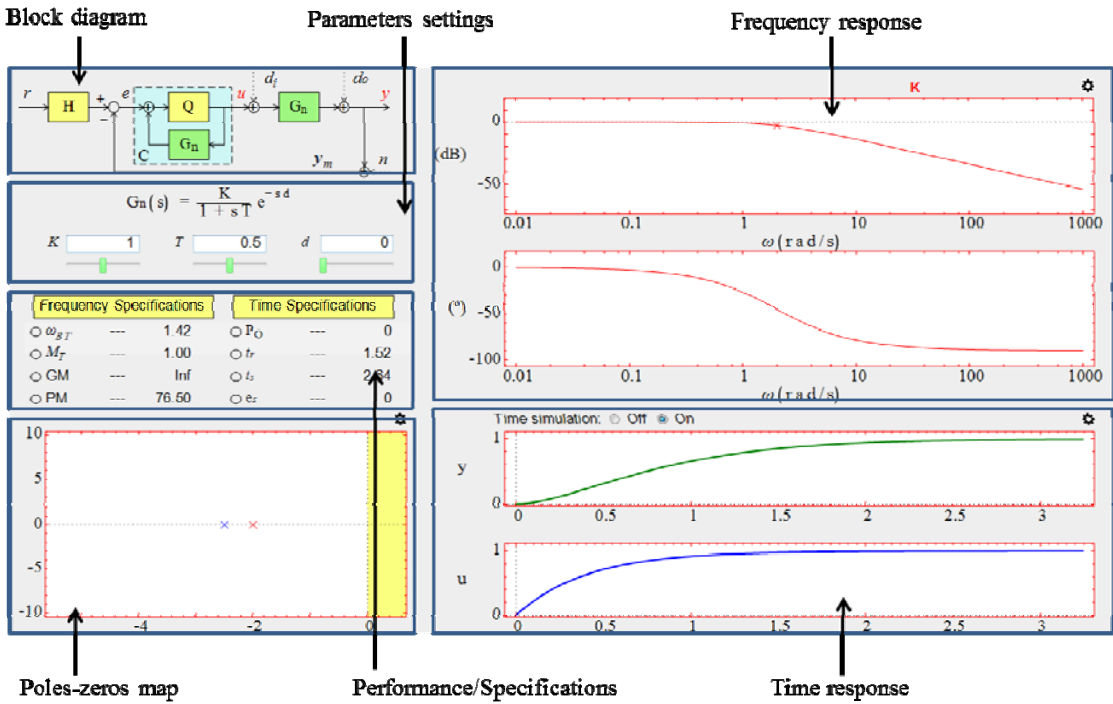

Figure 3. ITCLSD main window

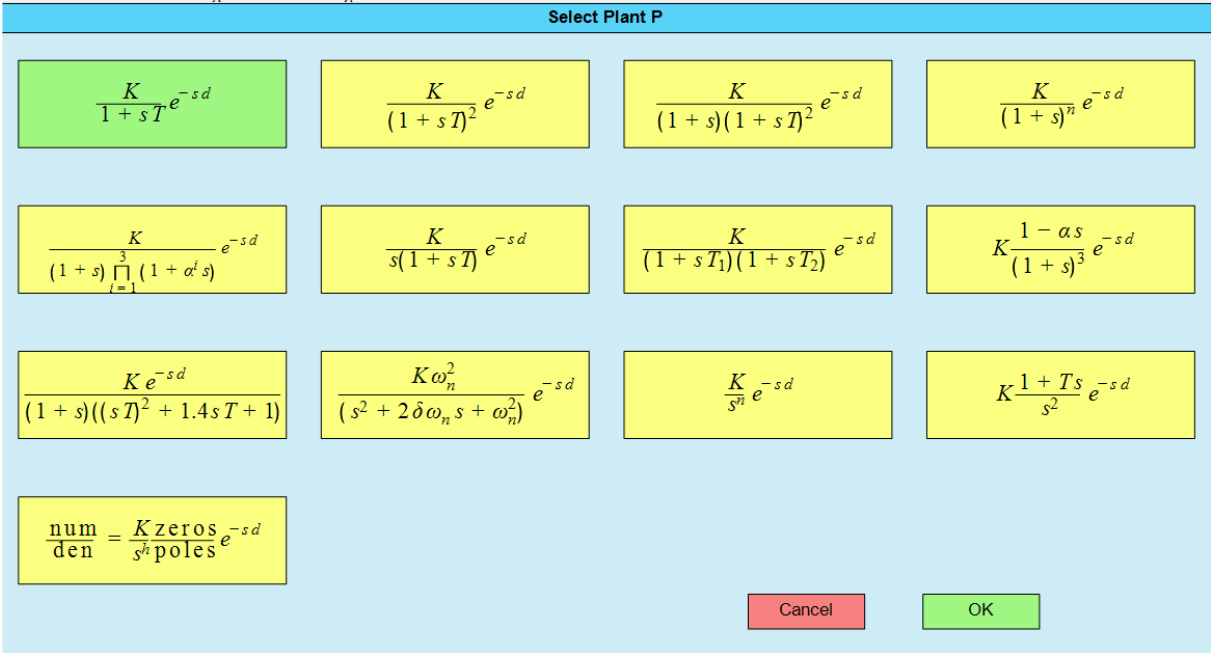
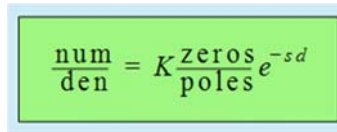

Figure 4. Auxiliary window to select the plant structure

The plant parameters can only be set if the block G_n of the *block diagram* zone has been previously selected, i.e., the block is in green colour. To select a block, the user has to click on it. ITCLSD allows the user to set the plant parameters from three zones (see Figure 3):

- *Parameters settings*. In this zone, there are text fields and sliders to configure the plant parameters. To insert a value in a text field the user has to click on it, write the value, and pulse the {Enter} key. To configure a plant parameter by a slider, the user has to locate the mouse pointer on the slider, hold down the mouse left button, drag left or right, and release the button. Note that, depending on the parameter, some values are not allowed. In this case, the value is not taken, or a dialog box is shown with a warning message.
- *Poles-zeros map*. In this zone, the following interactive elements are plotted: 'x' (real pole or integrator), bold 'x' (complex pole), 'o' (real zero or derivator), and bold 'o' (complex zero). Besides, the following colour code is used: red (plant G_n) and blue (filter Q , controller C , prefilter H). The user can drag the interactive elements to configure the poles and zeros. To drag an interactive element, the user has to place the mouse pointer on the element, hold down the mouse left button, drag the element to the desired position, and release the button. Note that, depending on the transfer function structure, some interactive elements cannot be dragged.
- *Frequency response*. In this zone, the following interactive elements are plotted: 'x' (real pole corner frequency), bold 'x' (complex pole corner frequency), 'o' (real zero corner frequency, and bold 'o' (complex zero corner frequency). The ITCLSD colour code is shown in Appendix A. The user can drag the interactive elements to configure the corner frequencies (and the damping factor in a complex pole or zero). To drag an interactive element, the user has to locate the mouse pointer on the element, hold down the mouse left button, drag the element to the wanted position, and release the button. Note that, depending on the transfer function structure, some interactive elements cannot be dragged.

If the user selects a user-defined plant (see Figure 5) in the auxiliary window (see Figure 4), the *parameters setting* zone takes, by default, the appearance of the Figure 6a.



$$\frac{\text{num}}{\text{den}} = K \frac{\text{zeros}}{\text{poles}} e^{-sd}$$

Figure 5. Icon of the user-defined plant in the auxiliary window of the Figure 4

The zone shows an interactive symbolic transfer function. Below the transfer function, the user can see information about it.

The interactive symbolic transfer function allows the user to configure the transfer function, and to control the information that is shown in the *parameters settings* zone. The user can do the following actions on the interactive transfer function:

- Click on $\frac{\text{num}}{\text{den}}$. The numerical transfer function is shown below of the symbolic transfer function (see Figure 6a).
- Click on *zeros*. The plant zeros are displayed below the symbolic transfer function (see Figure 6b).
- Click on *poles*. The plant poles are displayed below the symbolic transfer function (see Figure 6c).
- Click on *K* or e^{-sd} . Two text fields and sliders are displayed (see Figure 6d) to configure the plant gain K , and the plant delay d , respectively.
- Double click on $\frac{\text{num}}{\text{den}}$. A dialog box is shown to enter the polynomials of the numerator and the denominator.
- Double click on *zeros*. A dialog box is shown to enter the plant zeros.
- Double click on *poles*. A dialog box is shown to enter the plant poles.

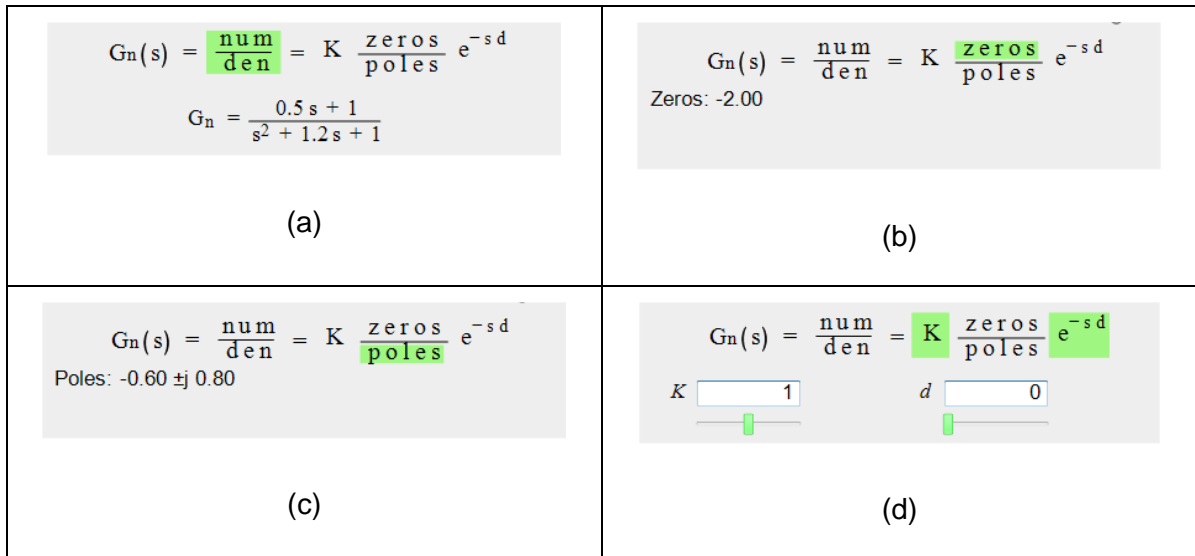

Figure 6. Possible appearances of the *parameters settings* zone when the user-defined plant is selected

The user can also do the following actions with the information displayed below the symbolic transfer function:

- Click on a zero or pole. If it is real, then two text fields and sliders are displayed to configure the real part Re or the time constant T . If it is complex, then four text fields and sliders are displayed to configure the real part Re , the imaginary part Im , the damping factor δ , and the natural frequency ω_n .
- Double click on a zero or pole. The element is removed from the transfer function. Note that a pole can be only removed if the new plant is strictly proper, i.e., the denominator degree is greater than the numerator degree.
- Because of space limitations, only nine zeros or poles can be displayed simultaneously. The zeros or poles are sorted in increasing order of real part. If the number of zeros or poles is greater than nine, then the symbols '<' and '>' are displayed in the right lower corner of this zone. The user can click on '<' or '>' to move the zeros or poles to the left or to the right.

By default, ITCLSD provides a user-defined plant G_n with a real zero and a pair of conjugate complex poles. The user can change this plant structure from the following zones:

- The symbolic transfer function of the *parameters settings* zone. The user can modify the plant numerator, denominator, poles, and zeros by double clicking on $\frac{\text{num}}{\text{den}}$, zeros, or poles.
- The *poles-zeros* zone. In the central upper part of this zone (see Figure 7a), there is an interactive repository where the user can do the following actions:
 - Drag an element from the repository to the poles-zeros map. This action adds the element to the plant structure. To drag an element, the user has to locate the mouse pointer on the element, hold down the mouse left button, drag the element to the wanted position inside the poles-zeros map, and release the button. Note that a zero can be only added if the new plant is strictly proper, i.e., the denominator degree is greater than the numerator degree.
 - Drag an element from the poles-zeros map to the repository. This action removes the element from the plant structure. Note that a pole can be only removed if the new plant is strictly proper, i.e., the denominator degree is greater than the numerator degree.
- The *frequency response* zone. In the right upper part of this zone (see Figure 7b), there is an interactive repository, with a functionality similar to the repository in the poles-zeros map (see the previous paragraphs), and a gain selector (see section 8).

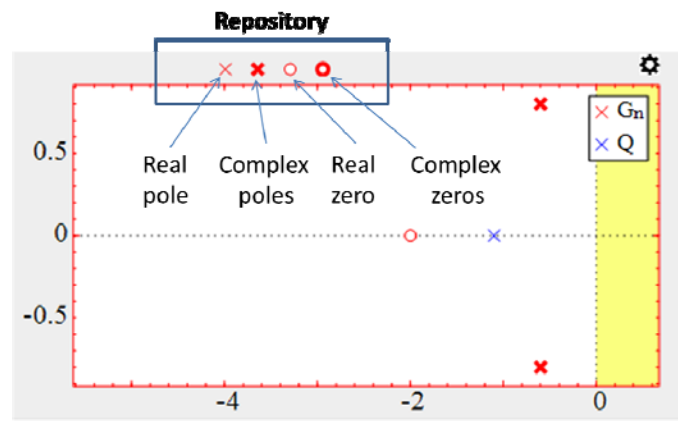

(a)

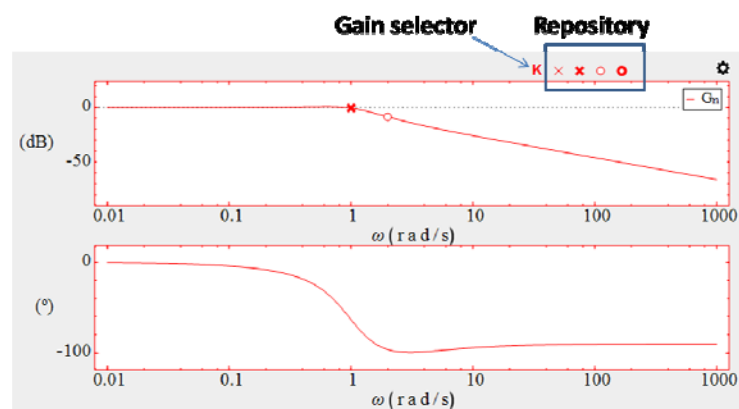

(b)

Figure 7. Repository of elements to configure an user-defined plant in: a) *Poles-zeros map zone*, b) *Frequency response zone*

4. Controller configuration

To configure the structure of the filter $Q(s)$, the user has to double click on the block Q of the *block diagram* zone, which is located in the left upper corner of the main window (see Figure 3). When the user does this action, an auxiliary window is shown (see Figure 8) with all the available structures for the filter $Q(s)$. ITCLSD implements three options to configure the structure of $Q(s)$:

- $\frac{1}{G_n(0)}$. If the user clicks on this box (see Figure 8b), then $Q(s)$ gain is fixed to the value $\frac{1}{G_n(0)}$. This option allows having an integrator in the controller $C(s)$.

- $\frac{1}{G_n^+}$. If the user clicks on this box (see Figure 8c), then $Q(s)$ is factorized in the form

$$Q(s) = F_q(s) \cdot \frac{1}{G_n^+(s)}, \quad (12)$$

where $F_q(s)$ is a strictly proper transfer function, and $\frac{1}{G_n^+(s)}$ is a stable approximation to $\frac{1}{G_n(s)}$. The user does not have to worry about configuring

$\frac{1}{G_n^+(s)}$, ITCLSD configures it automatically. Note that if the plant $G_n(s)$ has no nonminimum zeros or delay, then $G_n^+(s) = G_n(s)$. Therefore, according to (10),

$$T(s) = Q(s)G(s) = F_q(s) \cdot \frac{1}{G_n^+(s)} G(s) = F_q(s). \quad (13)$$

Thus, in this case, the design of $T(s)$ is done in a direct way by $F_q(s)$.

- C=PID. If the user clicks on this box (see Figure 8e), ITCLSD limits the order of $Q(s)$ (and $F_q(s)$) to obtain a PID controller with the following structure:

$$C(s) = K_p + \frac{K_I}{s} + \frac{K_D s}{\tau_D s + 1}, \quad (14)$$

where K_p is the proportional gain, K_I is the integral gain, K_D is the derivative gain, and is the τ_D derivative time constant. Note that this option is only shown if the plant $G_n(s)$ is the first or second order. Besides, note that if the user selects this option, then the previous two options are automatically selected, because they are necessary to get a PID controller [Goodwin et al., 2001].



Figure 8. Possible appearances of auxiliary window to select the filter $Q(s)$ structure

$Q(s)$ (or $F_q(s)$) transfer function can only be set if the block Q of the *block diagram* zone has been previously selected, i.e., the block is in light green colour. Remind that to select a block, the user has to click on it. $Q(s)$ (or $F_q(s)$) transfer function setting is similar to the plant setting described in section 3. $Q(s)$ (or $F_q(s)$) poles, zeros, and frequency response are shown in blue colour.

ITCLSD main window can also show information about the controller $C(s)$. The user only have to select the block C, which is shown in light blue colour (see Figure 9a). When the user click on it, the block C is selected, and it is represented in dark blue colour (see Figure 9b), and all the information about the controller $C(s)$ is shown in the main

window. Note that unlike the other blocks, the block C is not represented in light green colour when is selected, because it cannot be directly configured. Remind that the design of the controller $C(s)$ is done by the filter $Q(s)$.

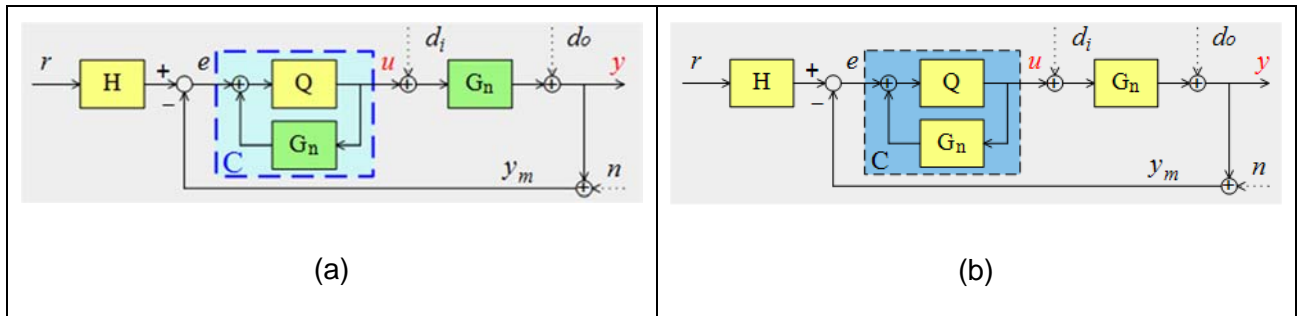

Figure 9. Appearance of the block C in the *block diagram* zone: a) Before the user clicks on it. b) After the user clicks on it.

5. Prefilter configuration

To configure the prefilter $H(s)$, the user has to double click on the block H of the block diagram zone, which is located in the left upper corner of the main window (see Figure 3). When the user does this action, an auxiliary window is shown (see Figure 10) with all the available prefilter structures. ITCLSD has five prefilter structures: four predefined and one user-defined. The user has to click on the wanted structure (the block takes a light green colour), and pulse the button OK.

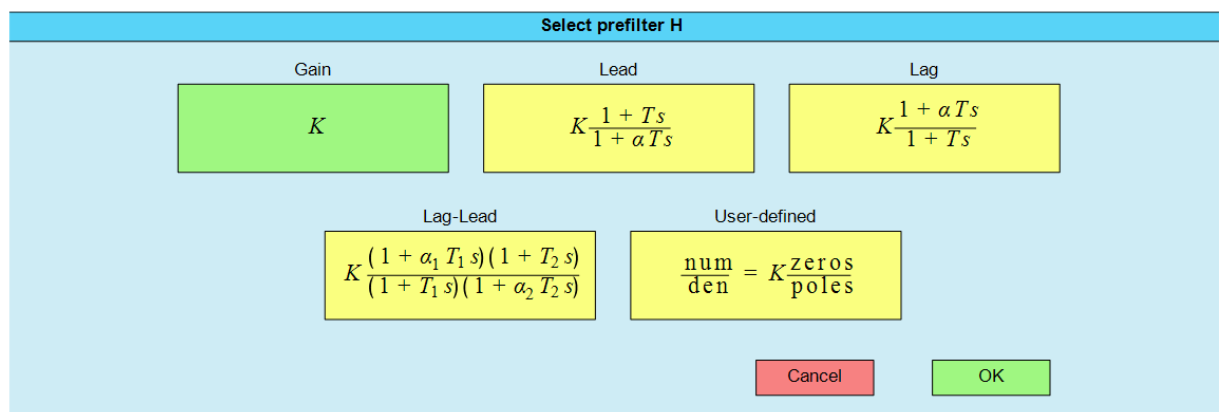

Figure 10. Auxiliary window to select the prefilter structure

The prefilter parameters can only be set if the block H of the *block diagram* zone has been previously selected, i.e., the block is in light green colour. To select a block, the user has to click on it. The prefilter parameters settings are similar to the plant parameters settings (see section 3).

ITCLSD draws the prefilter elements (poles, zeros, corner frequencies, and, frequency response) in blue colour.

6. Inputs configuration

This version of ITCLSD implements in the *block diagram* zone a classical control system of two degrees of freedom that has four inputs: the reference signal r , the plant input disturbance d_i , the plant output disturbance d_o , and the measurement noise n . By default, disturbances and noise are disabled; and their arrows are drawn in dotted line (see Figure 11). To enable a disturbance or the noise, the user has to click on the corresponding arrow. When a disturbance or the noise is enabled, its arrow is drawn in solid line (see Figure 11). To disable a disturbance or the noise, the user also has to click on its arrow.

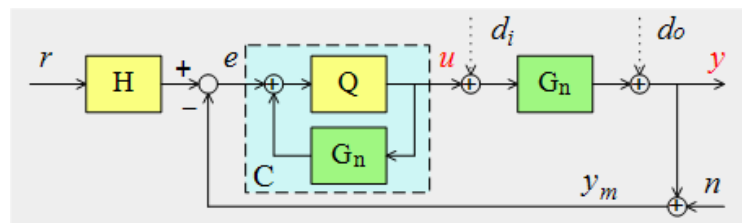

Figure 11. *Block diagram* zone, the disturbances d_i and d_o are disabled (their arrows are drawn in dashed line), and the noise n is enabled (its arrow is drawn in solid line).

ITCLSD implements six types of inputs: pulse, step, ramp, parabola, sinusoid, and white noise. To select the type of an input, the user has to double click on the label associated to an input. For example, to select the type of the reference r , the user has to double click on the label r in the *block diagram* zone. When the user does this action, an auxiliary window is shown in the screen (see Figure 12) with all the available types of inputs. The user only has to click on the desired type (light green) and click on the OK button.

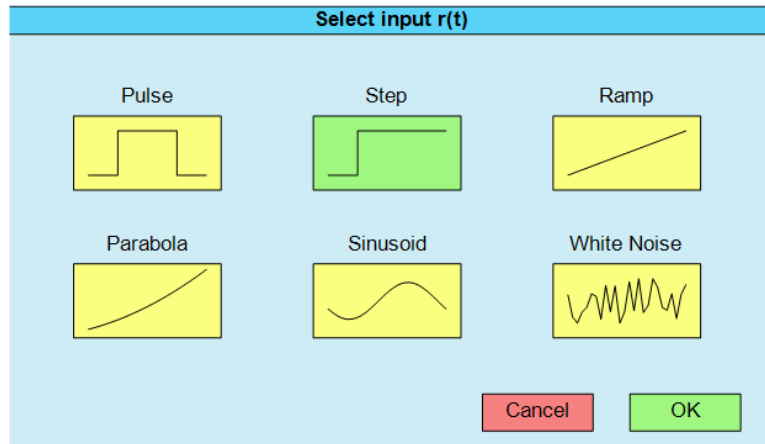

Figure 12. Auxiliary window to select the type of an input

To configure the parameters of an input, the user has to click on the corresponding label in the *block diagram* zone. Notice that a light green square is drawn around the label. The parameters of an input can be configured in the *parameters settings* zone by text fields or sliders. For example, suppose that the user clicks on the label r in the *block diagram* zone (see Figure 13), the label r is enclosed within a light green square. In this example, the reference is a step. This type of input has two parameters: the amplitude a and the delay d . There are two text fields and sliders in the *parameters settings* zone to configure these parameters.

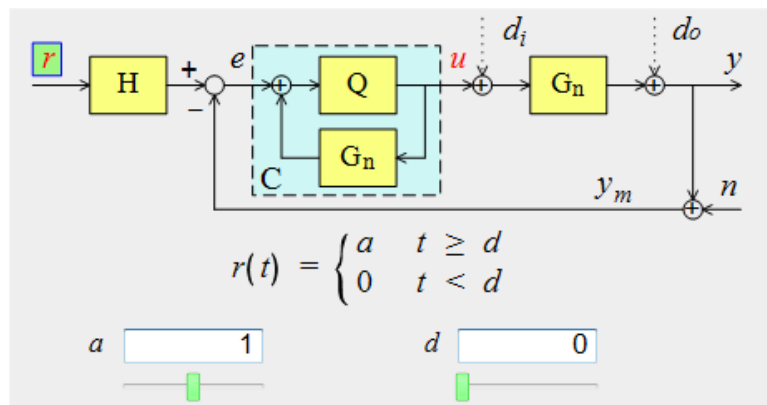

Figure 13. Configuration of the parameters of the input r

7. Poles-zeros map

The *poles-zeros map* zone is located in the left bottom corner of the main window (see Figure 3).

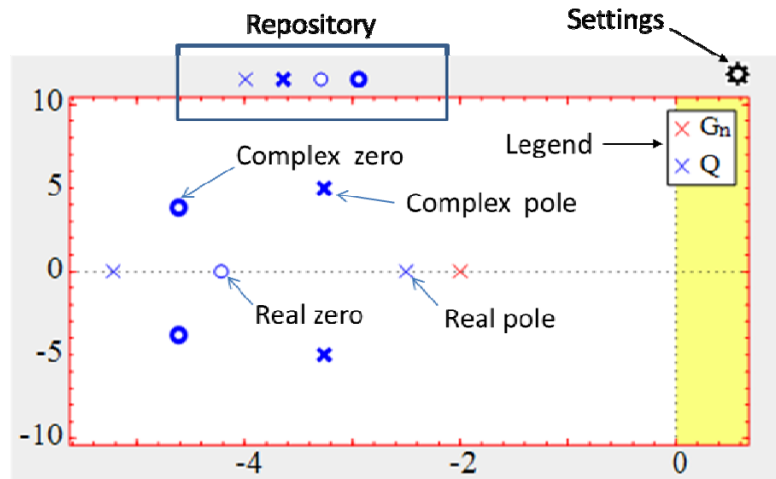

Figure 14. Interactive elements of the zone *poles-zeros map*

In this zone, the following interactive elements are available (see Figure 14):

- Poles and zeros. The following symbols are used: 'x' (real pole or integrator), bold 'x' (complex pole), 'o' (real zero or derivator), and bold 'o' (complex zero). The following colour code is used: red (plant $G_n(s)$), blue (filter $Q(s)$ or $F_q(s)$, controller $C(s)$, and prefilter $H(s)$). To drag pole or zero, the user has to locate the mouse pointer on the element, hold down the mouse left button, drag the element to the wanted position, and release the button. Note that to drag an interactive elements (poles or zeros) of a certain transfer function (plant, filter, or prefilter), the corresponding block in the *block diagram* zone has to be selected (light green colour). Besides, depending on the transfer function structure, some interactive elements cannot be dragged.
- Repository. The user can do the following actions with this interactive element:
 - Drag an element (pole or zero) from the repository to the poles-zeros map. This action adds the element to the transfer function. To drag an element, the user has to locate the mouse pointer on the element, hold down the mouse left button, drag the element to the wanted position inside the

- poles-zeros map, and release the button. Note that a zero can be only added if the transfer function has a number of poles greater than zeros.
- Drag an element (pole or zero) from the poles-zeros map to the repository. This action removes the element from the transfer function. Note that a pole can be only removed if the number of zeros is lower to the number of poles.
 - Legend. By default, it is located in the upper right corner of the poles-zeros map. The user can change the position of the legend to any corner of the poles-zeros map. To do that, he/she has to locate the mouse pointer on the legend, hold down the mouse left button, and drag the legend to the wanted corner. Besides, the legend can be hidden by the corresponding option in the pole-zero map settings.
 - Settings. It is located in the upper right corner of the zone, and is represented by a gearwheel icon. When the user clicks on this icon, an auxiliary window is shown (see Figure 15). It allows hiding the legend and configuring the scale of the poles-zeros map. The user can select the type of scale by clicking on the corresponding radio button:
 - *Locked*. The axes limits are set by the user in the text fields and sliders of the auxiliary window.
 - *Variable*. The axes limits are set automatically by ITCLSD to display all the poles and zeros.

Poles-Zeros Map Settings

Legend: No Yes

Scale: Locked Variable

x_{\min} x_{\max}

y_{\min} y_{\max}

Figure 15. Auxiliary window to poles-zeros map settings

8. Frequency response

The *frequency response* zone is located in the right upper corner of the main window (see Figure 3). The user has to type the key {b} to display the Bode diagram, the key {p} to display the polar (Nyquist) diagram, or the key {n} to display the Nichols diagram. The size of this zone can also be set by the keys: {0} small, {1} medium, {2} large, and {3} huge.

It is also possible to select the type and size of the frequency response diagram clicking on the gearwheel icon located in the right upper corner of the zone (see Figure 16 and Figure 19)

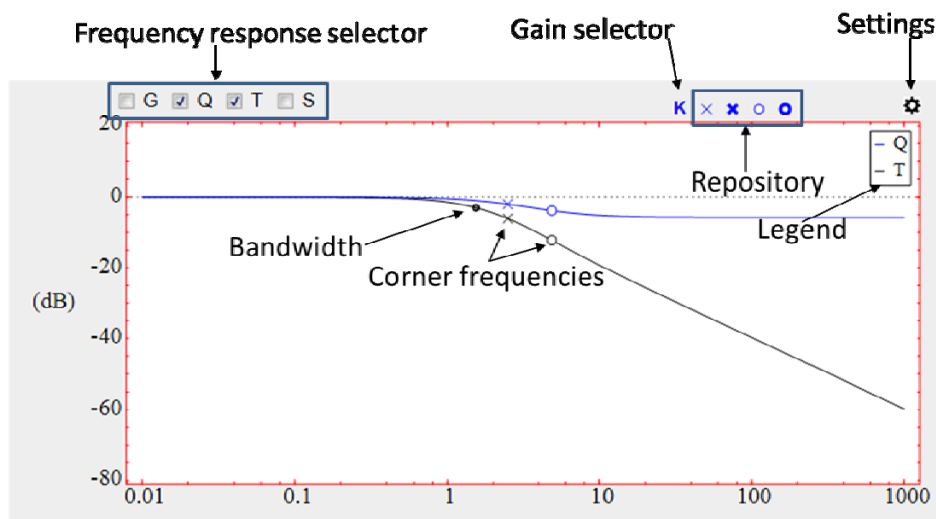

Figure 16. Frequency response zone with a Bode plot diagram

In this zone, the following elements are available (see Figure 16):

- Bode, polar or Nichols curves for the plant $G_n(s)$ (red), the filter $Q(s)$ (blue), the complementary sensitivity function $T(s)$ (black), the sensitivity function $S(s)$ (green), the controller $C(s)$ (blue), the open loop function $L(s)$ (black), the prefilter $H(s)$ (blue), and $H(s)T(s)$ (black). The user can choose the functions, whose frequency responses are plotted in this zone, by the selector located in the left upper square. He/she only has to click on the box associated to certain transfer function to show or hide its frequency response. Note that the available functions in the selector depend on the selected block in the *block diagram* zone.

For example, when the block Q is selected, then the available functions in the selector are G, Q, T, and S, (see Figure 16).

- Gain selector. It is located in the central upper part of the zone. To enable or disable the selector, the user has to click on it. When the gain selector is enabled, it is enclosed within a light green square (see Figure 17), and the user can configure the gain of the frequency response. To increase (or decrease) the gain, the user has to drag vertically upward (or downward) the Bode magnitude curve, the polar curve, or the Nichols curve. Once the user has finished configuring the gain, he/she has to click on the gain selector to disable it.



Figure 17. Enabled gain selector

- Corner frequencies. They are represented with the following interactive elements: 'x' (real pole corner frequency), bold 'x' (complex pole corner frequency), 'o' (real zero corner frequency, and bold 'o' (complex zero corner frequency). The colour code is the same that has been described in the previous paragraph. Note that only the corner frequencies of the block selected (light green colour) in the *block diagram* zone are plotted. In the case of $Q(s)$, if the option $\frac{1}{G_n^+}$ or C=PID are selected (see section 4), then the corner frequencies of $F_q(s)$ are only plotted. Likewise, for $S(s)$, if the option design $S(s)$ is selected (see section 10), the corner frequencies of its poles are only plotted, the corner frequencies of its zeros are not plotted.

To configure the corner frequency of a pole ('x') or a zero ('o'), the user has to locate the mouse pointer on the interactive element, and drag the element to the desired position. A corner frequency can only be dragged horizontally to the left (or to the right). Figure 18 shows the meaning of the displacements in Bode diagram, polar diagram, and Nichols diagram.

Note that to configure the parameters of $T(s)$, the user can work on the interactive elements of $Q(s)$ or $T(s)$. Likewise, to configure $S(s)$, the interactive elements of $Q(s)$ or $S(s)$ can be used.

When the user finishes a drag operation, ITCLSD updates the information in all the zones of the main window. If the time simulation takes a long time, in order to short the update, the user should disable the time simulation (see section 9).

- Damping ratio δ of a pair of complex poles or zeros. To configure the damping ratio δ of a pair of complex poles ('x') or zeros ('o') in the Bode magnitude plot, the user has to locate the mouse pointer on the corner frequency, and drag vertically upward or downward (see Figure 18)

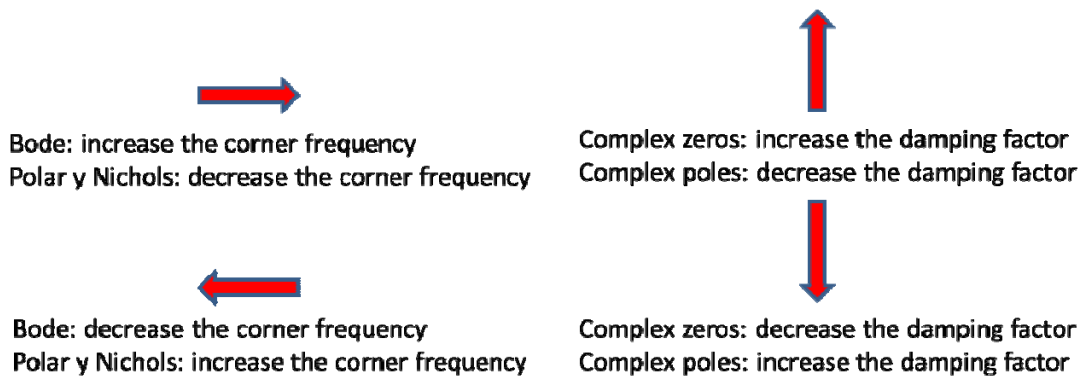

Figure 18. Meaning of the displacements in Bode magnitude diagram, polar diagram, and Nichols diagram

- Bandwidth. It is represented with a small solid circle in the Bode magnitude plot of $T(s)$ (black) and $S(s)$ (green). ITCLSD follows the bandwidth definition given in [Skogestad and Postlethwaite, 2005] (see section 10).
- Frequency specifications. These specifications are described in section 10.
- Repository and legend. The functionality of these elements is described in section 7.
- Settings. It is located in the upper right corner of the zone, and is represented by a gearwheel icon. When the user clicks on this icon, an auxiliary window is shown (see Figure 19) to choose several options of the frequency response: type of diagram (Bode, polar, or Nichols), size (small, medium, large or huge), the visualization of the legend, the units of the Bode magnitude (decibels (dB) or arithmetic units (au)), the scale, the visualization of the frequency response points, and the number of points. There are two types of scale:

- *Locked* scale. If the checkmark *Equal* is not marked (this condition is only necessary in the polar diagram), then the user can set the axes limits in the text fields and sliders of the auxiliary window. The following nomenclature is used: magnitude in dB (M), phase in degrees (P), frequency in radians per second (ω).
- *Variable* scale. The axes limits are set automatically by ITCLSD to display all the poles and zeros.

The user can select the type of scale by clicking on the corresponding radio button: *locked* or *variable*. In the polar diagram, if the user selects the checkmark *Equal*, then the same linear scale is used for x and y axes.

Besides, in this auxiliary window, the user can configure the points number N_ω that are plotted in the frequency response. N_ω must be an integer in the range [50,2000]. If N_ω is greater than 500, then the computational burden increases, and the interactivity gets worse. The user can also choose whether or not to shown these points on the frequency response. In affirmative case, if the user locates the mouse pointer on a point, its coordinates are displayed.

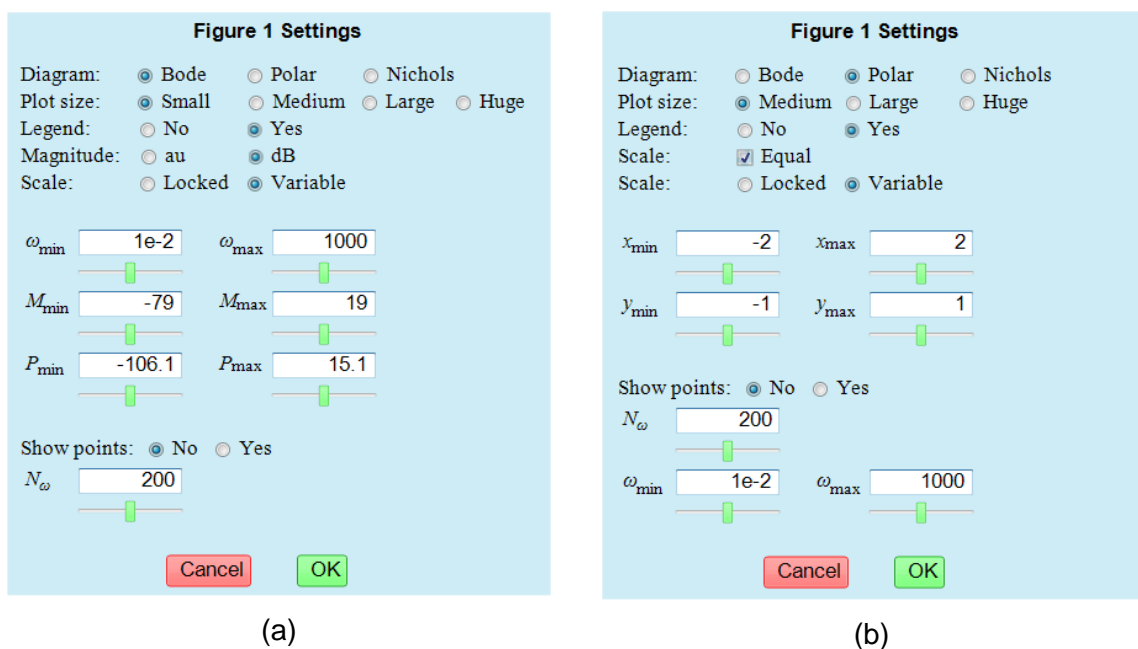
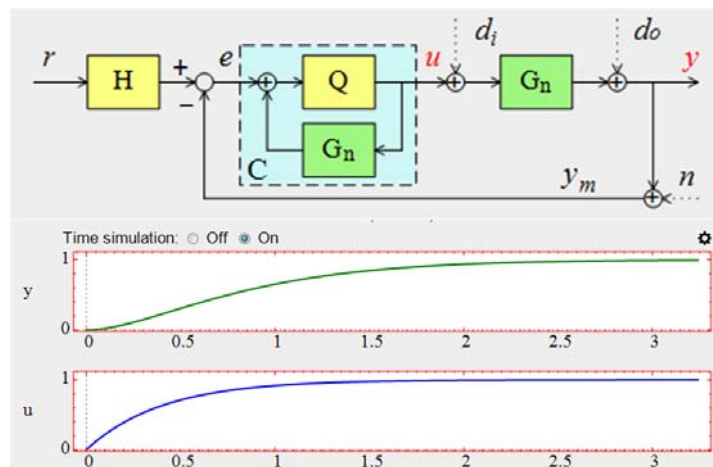

Figure 19. Auxiliary window to configure different options of the *frequency response* zone: a) Bode diagram, b) Polar diagram and Nichols diagram.

9. Time response

The *time response* zone is located in the right lower corner of the ITCLSD main window (see Figure 3). Up to two signals (r, e, u, d_i, d_o, y, n , and y_m) can be plotted in this zone. The signals are plotted in solid line. In this zone, time specifications can also be plotted (see section 11) as a combination of yellow rectangles that establishes forbidden regions for y or u .

The user can choose the signals to display. In the *block diagram* zone, the user must click on the label associated to the signal (r, e, u, d_i, d_o, y, n , and y_m) that he wants visualise. If a signal is selected to display, then its label is in red colour (see Figure 20). Otherwise, its label is in black colour.



(a)

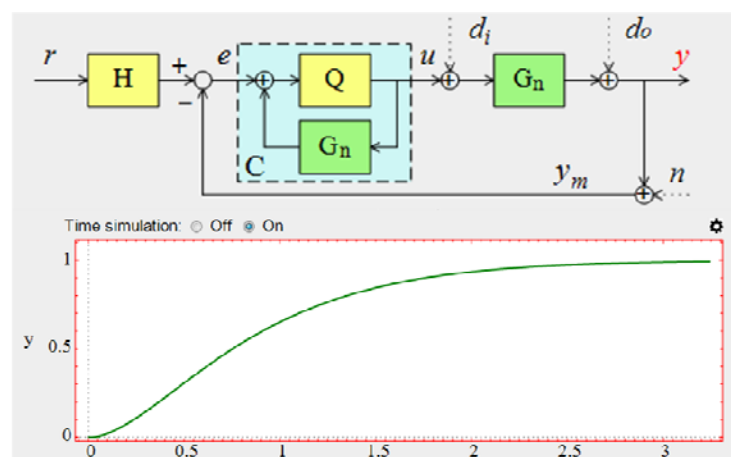

(b)

Figure 20. Relation between the *block diagram* zone and *time response* zone : a) Two signals are selected. b) One signal is selected.

The user can select the type of scale by clicking on the corresponding radio button: *locked* or *variable*. Besides, in this auxiliary window, the user can choose whether or not to show the time responses points. In affirmative case, if the user locates the mouse pointer on a point, its coordinates are displayed.

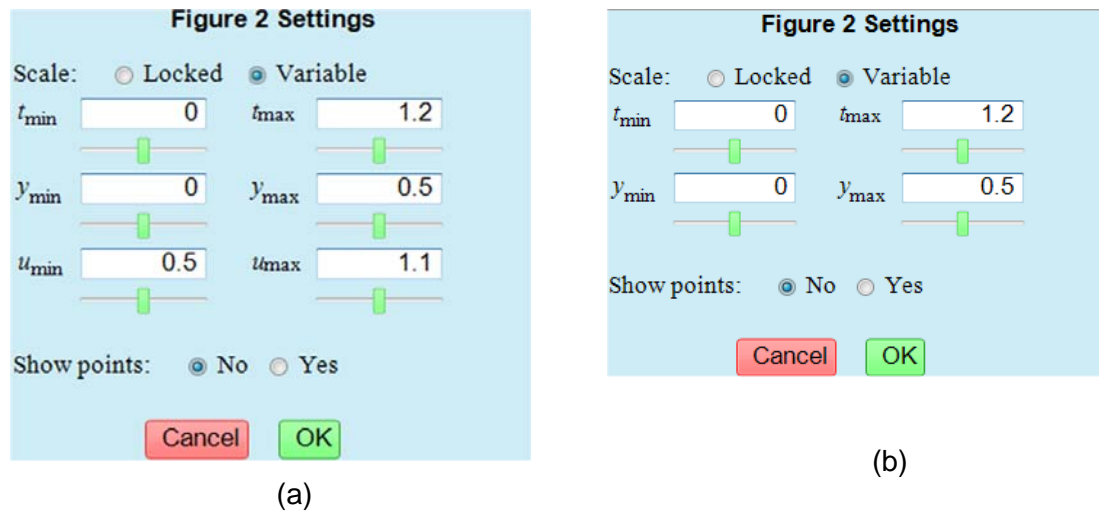

Figure 22. Auxiliary window to configure the scale in the *time response* zone:

a) Two signals (*u* and *y*) are plotted. b) One signal (*y*) is plotted.

10. Frequency performance/specifications

The *performance/specifications* zone is located in the left central part of the ITCLSD main window (see Figure 3). Figure 23 shows an example of the appearance of this zone when there are not enabled specifications. In this case, the buttons *Frequency specifications* and *Time Specifications* are in yellow colour. Besides, there is a table with frequency and time characteristics.

In the left part of this table, the following frequency characteristics of the system are shown [Skogestad and Postlethwaite, 2005]:

- Gain margin GM . It is defined by

$$GM = \frac{1}{|L(j\omega_{180})|} \quad (14)$$

where ω_{180} is the *phase crossover frequency*, the largest frequency where the phase of open loop transfer function $L(j\omega) = C(j\omega) \cdot G(j\omega)$ crosses the value -180° , i.e.

$$\arg L(j\omega_{180}) = -180^\circ \quad (15)$$

The GM is the factor by which the loop gain $|L(j\omega)|$ may be increased before the closed-loop shaping becomes unstable. The GM is thus a direct safeguard against steady-state gain uncertainty (error). Typically we require $GM > 2$

- Phase margin PM . It is defined as

$$PM = 180^\circ + \arg L(j\omega_c) \quad (16)$$

where ω_c is the *gain crossover frequency*, the first frequency where the magnitude of $L(j\omega)$ crosses the value 1 (0 dB) , i.e.

$$|L(j\omega_c)| = 1 \quad (17)$$

The PM tells how much negative phase (phase lag) we can add to $L(s)$ at frequency ω_c before the phase at this frequency becomes -180° which corresponds to closed-loop instability It is the amount of phase shift at the gain crossover frequency ω_{gc} that would just produce instability. The PM is a direct safeguard against time delay uncertainty. Typically, we require $PM > 30^\circ$.

- Maximum peak of the complementary sensitivity function M_T . It is defined as

$$M_T = \max_{\omega} |T(j\omega)| \quad (18)$$

Typically, it is required that $M_T < 1.25$ (2 dB). A large value of M_T (larger than about 4) indicates poor performance as well as poor robustness. A given value of M_T guarantees a lower limit for GM and PM :

$$GM \geq 1 + \frac{1}{M_T}; \quad PM \geq 2 \arcsin\left(\frac{1}{2M_T}\right) \geq \frac{1}{M_T} \text{ [rad]} \quad (19)$$

For example with $M_T = 2$, we have $GM \geq 1.5$ and $PM \geq 29.0^\circ$.

- Maximum peak of the sensitivity function M_S . It is defined as

$$M_S = \max_{\omega} |S(j\omega)| \quad (20)$$

Typically, it is required that $M_S < 2$ (6 dB). A large value of M_S (larger than about 4) indicates poor performance as well as poor robustness. A given value of M_T guarantees a lower limit for GM and PM:

$$GM \geq \frac{M_S}{M_S - 1}; \quad PM \geq 2 \arcsin\left(\frac{1}{2M_S}\right) \geq \frac{1}{M_S} \text{ [rad]} \quad (21)$$

For example with $M_S = 2$, we have $GM \geq 2$ and $PM \geq 29.0^\circ$.

- Bandwidth ω_{BS} . It is the frequency where $|S(j\omega)|$ first crosses $1/\sqrt{2} = 0.707 (\approx -3dB)$ from below. A large (closed-loop) bandwidth ω_{BS} corresponds to a faster rise time. It also indicates a system which is sensitive to noise and to parameters variations. Conversely, if the bandwidth is small, the time response will generally be slow, and the system will usually be more robust.
- Bandwidth ω_{BT} . It is the highest frequency at which $|T(j\omega)|$ first crosses $1/\sqrt{2} = 0.707 (\approx -3dB)$ from above. This is an alternative definition to the concept of bandwidth. The gain crossover frequency ω_c is also sometimes used to define closed-loop bandwidth, because it is simple to compute. For systems with $PM < 90^\circ$ (most practical systems) it can be demonstrated [Skogestad and Postlethwaite, 2005] that

$$\omega_{BS} < \omega_c < \omega_{BT} \quad (22)$$

Besides, it can also be demonstrated [Skogestad and Postlethwaite, 2005] that ω_{BS} is a better indicator of closed-loop performance than ω_{BT} .

Frequency Specifications			Time Specifications				
<input type="radio"/>	ω_{BT}	---	1.42	<input type="radio"/>	P_O	---	0
<input type="radio"/>	M_T	---	1.00	<input type="radio"/>	t_r	---	1.52
<input type="radio"/>	GM	---	Inf	<input type="radio"/>	t_s	---	2.64
<input type="radio"/>	PM	---	76.50	<input type="radio"/>	e_s	---	0

(a)

Frequency Specifications			Time Specifications				
<input type="radio"/>	ω_{BS}	---	0.90	<input type="radio"/>	P_O	---	0
<input type="radio"/>	M_S	---	1.15	<input type="radio"/>	t_r	---	1.52
<input type="radio"/>	GM	---	Inf	<input type="radio"/>	t_s	---	2.64
<input type="radio"/>	PM	---	76.50	<input type="radio"/>	e_s	---	0

(b)

Figure 23. An example of the *Performance/specifications* zone when there are not enabled specifications, and the user has selected to design: a) $T(s)$. b) $S(s)$.

Note that if the user chooses to design $T(s)$, then M_T and ω_{BT} are shown in the table (see Figure 23). Conversely, if the user chooses to design $S(s)$, then M_S and ω_{BS} are shown. To select the function to design, and enable or disable a certain specification, the user has to do the following steps:

1. Click on the button *Frequency specifications*. An auxiliary window (see Figure 24) is shown on the screen.
2. Click on the circular box associated to the function that he/she wants to design, and click on the box associated to the specifications that he/she wants to enable or disable.
3. Click on OK.

If there is some enabled frequency specification, then the left part of the table is replaced with information about the enabled specifications. To display the frequency characteristics in the left part of the table, the user has to type the key $\{e\}$. To display information about the enabled frequency specifications, the user has to type again the key $\{e\}$.

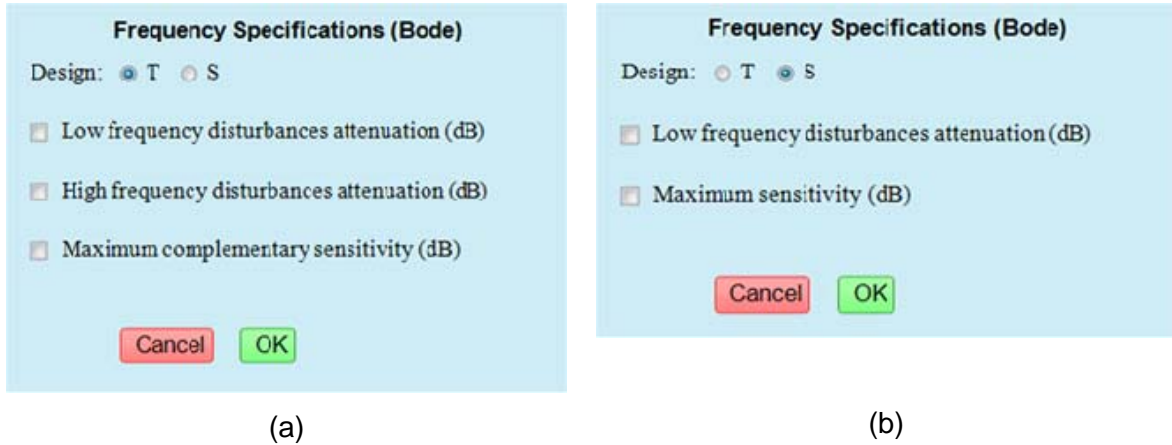

Figure 24. Auxiliary window to configure the frequency specifications to design a) $T(s)$ or b) $S(s)$.

When there are frequency enabled specifications, the *performance/specifications* zone changes the appearance, and the left part shows information about the enabled specifications (see Figure 25). For each enabled specification, the following information is displayed:

- Circular indicator. The green colour means the specification is fulfilled. Otherwise (red colour), the specification is not fulfilled.
- Specifications symbol. If the user places the pointer mouse on this symbol, a text shows the meaning of the symbol.
- Specification value. The green colour means the specification is fulfilled. Otherwise (red colour), the specification is not fulfilled.
- System value for this characteristic. This value can be a real number or infinite (Inf). If the value doesn't exist, then the symbol NaN is shown. If ITCLSD cannot compute automatically the value or the Time Simulation is off, then the value -1 is shown.

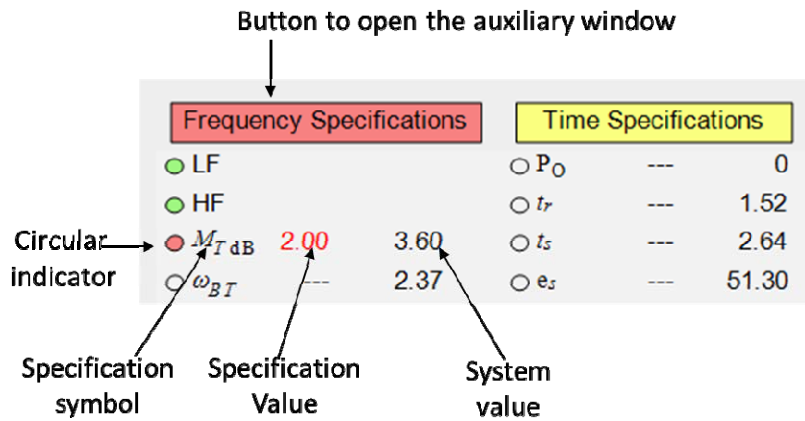

Figure 25. Possible aspect of the *performance/specifications* zone when there are enabled frequency specifications

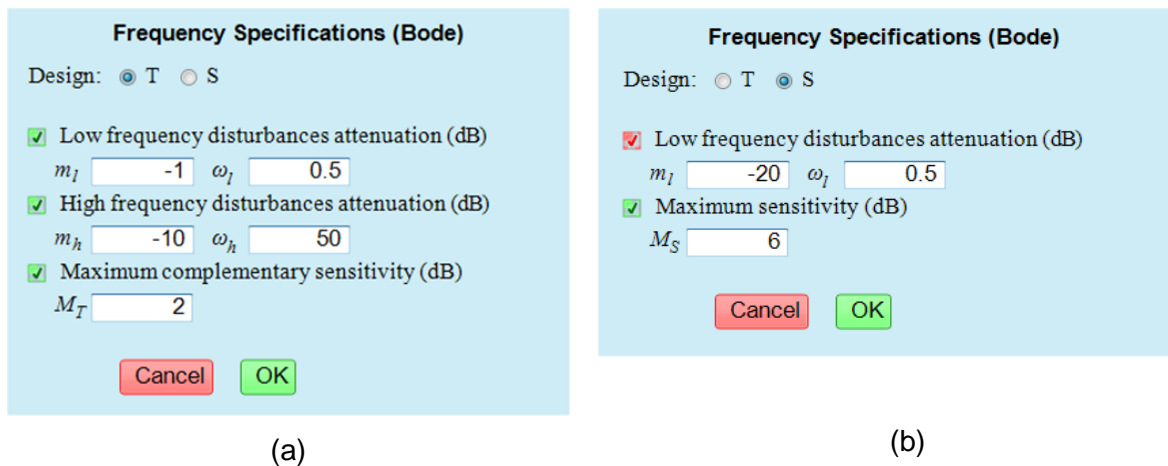

Figure 26. Text fields to configure the enabled frequency specifications to design a) $T(s)$ or b) $S(s)$.

In addition, the button *Frequency Specifications* is in red or green colour. The red colour means that some frequency specification is not fulfilled. On the contrary, green colour means that all the frequency specifications are fulfilled.

To set the value of an enabled specification, the user has to do the following steps:

1. Click on the button *Frequency specifications*. When the user executes this action, an auxiliary window (see Figure 26) is show on the screen.

2. Write the value in the text field below the specification. Some specifications can also be set dragging some interactive element associated to this specification in the *frequency response zone*.
3. Click on OK.

ITCLSD implements three frequency specifications to design $T(s)$:

- *Low frequency disturbances attenuation (LF)*. This specification is defined as

$$|T(j\omega)| \geq m_l \quad \forall \omega \leq \omega_l \quad (23)$$

It has two parameters m_l and ω_l , which can be configured by two text fields in the auxiliary window (see Figure 26a) if the specification has been previously enabled. Note that m_l cannot be greater than 0 dB.

Depending on the frequency diagram, the LF specification has a certain graphical representation:

- Bode diagram (see Figure 27a). The specification takes the form of a yellow rectangle, which defines a forbidden region for $|T(j\omega)|$. The width of this region is ω_l , and the upper bound is m_l dB. $|T(j\omega)|$ must be outside the yellow rectangle to fulfil the specification.
- Polar diagram (see Figure 27b). The specification takes the form of two circumferences: one exterior circumference in blue solid line, and one interior circumference in blue dashed line. The radius of the exterior circumference is m_l (expressed in arithmetic units). It establishes a boundary for $T(j\omega)$ if $\omega \leq \omega_l$. The interior circumference is drawn to indicate where is the forbidden region for $T(j\omega)$ if $\omega \leq \omega_l$. In this case, the forbidden region is a disk of radius m_l (expressed in arithmetic units). To help the user to know whether $T(j\omega)$ fulfils the specification, two blue points, $T(j\omega_l)$ and $T(j0)$ ¹, are drawn in the polar curve of $T(j\omega)$. To

¹ Numerically, ITCLSD considers $\omega = 10^{-20}$ instead of $\omega = 0$.

fulfil this specification the polar curve between these two points must be outside the exterior circumference.

- Nichols diagram (see Figure 27c). The specification takes the form of two blue horizontal lines: one solid line, and one dashed line. The magnitude in dB of the solid line is m_l . It establishes a boundary for $T(j\omega)$ if $\omega \leq \omega_l$. The dashed line is drawn to indicate where is the forbidden region for $T(j\omega)$ if $\omega \leq \omega_l$. In this case, the forbidden region is all the space below the solid line. To help the user to know whether $T(j\omega)$ fulfils the specification, the points $T(j\omega_l)$ and $T(j0)$ are drawn in blue in the Nichols curve of $T(j\omega)$. To fulfil this specification the Nichols curve between these two points must be above the blue solid line.

If the auxiliary window (see Figure 26a) is displayed on the main window, apart from the text fields, the user can also configure the LF specification dragging certain interactive elements in the *frequency response* zone. In the Bode diagram (see Figure 27a), the user can drag vertically upward or downward the red point 1 to configure m_l , and drag horizontally to left or right the red point 2 to configure ω_l . In the Polar diagram (see Figure 27b), the user can configure m_l dragging the exterior circumference 1. And in the Nichols diagram (see Figure 27c), the user can drag vertically upward or downward the blue solid line 1 to configure m_l .

- High frequency disturbances attenuation (HF). This specification is defined as

$$|T(j\omega)| \leq m_h \quad \forall \omega \geq \omega_h \quad (24)$$

It have two parameters m_h and ω_h , which can be configured by text fields in the auxiliary window (see Figure 26a) if the specification has been previously enabled. Note that m_l cannot be greater than 0 dB.

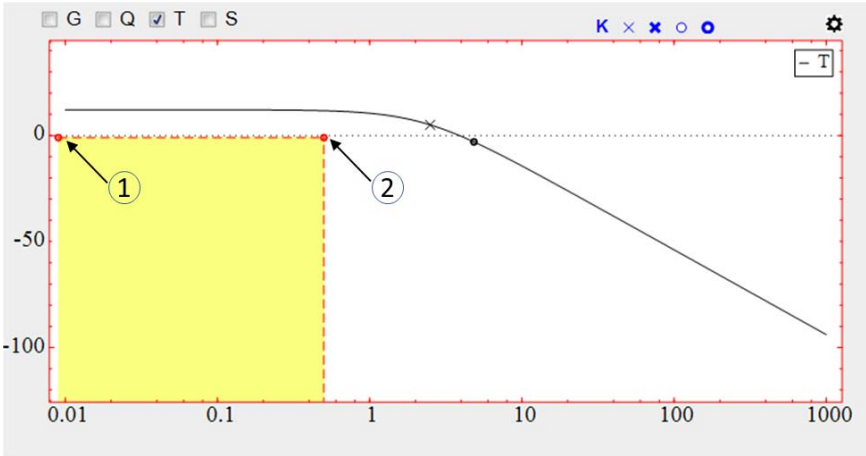

(a)

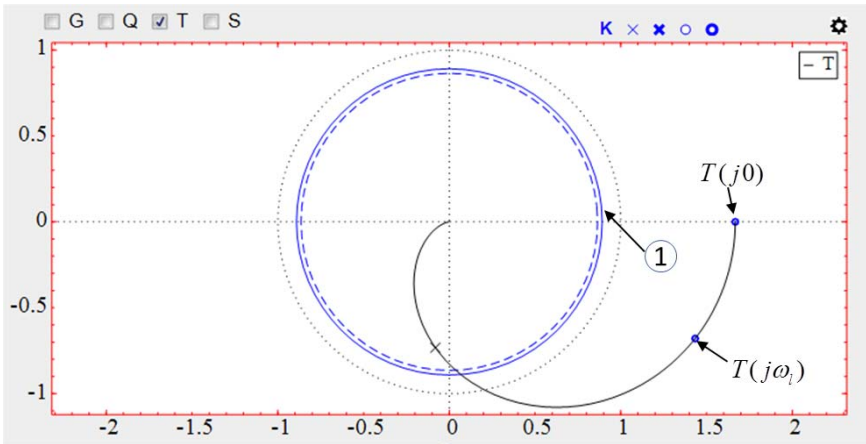

(b)

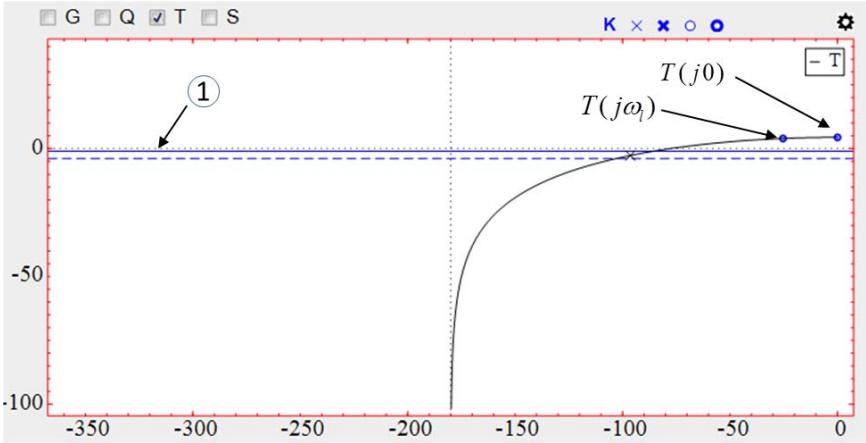

(c)

Figure 27. Specification low frequency disturbances attenuation (LF) for $T(j\omega)$ in a) Bode diagram, b) Polar diagram, and c) Nichols diagram.

Depending of the frequency diagram, the HF specification has a certain graphical representation:

- Bode diagram. The specification takes the form of a yellow rectangle (see Figure 28a), which defines a forbidden region for $|T(j\omega)|$. The width of this region is ω_h , and the lower bound is m_h dB. $|T(j\omega)|$ must be outside the yellow rectangle to fulfil the specification. Besides, ITCLSD allows configuring a more complex high frequency specification (see Figure 28b).
- Polar diagram (see Figure 28b). The specification takes the form of two circumferences: one exterior circumference in red dashed line, and one interior circumference in red solid line. The radius of the interior circumference is m_h (expressed in arithmetic units). It establishes a boundary for $T(j\omega)$ if $\omega \geq \omega_h$. The exterior circumference is drawn to indicate where is the forbidden region for $T(j\omega)$ if $\omega \geq \omega_h$. In this case, the allowed region is the disk of radius m_h (expressed in arithmetic units). To help the user to know whether $T(j\omega)$ fulfils the specification, two red points, $T(j\omega_h)$ and $T(j\infty)^2$, are drawn in the polar curve of $T(j\omega)$. To fulfil this specification the polar curve between these two points must be inside the interior circumference.
- Nichols diagram (see Figure 28c). The specification takes the form of two red horizontal lines: one solid line, and one dashed line. The magnitude in dB of the solid line is m_h . It establishes a boundary for $T(j\omega)$ if $\omega \geq \omega_h$. The dashed line is drawn to indicate where is the forbidden region for $T(j\omega)$ if $\omega \geq \omega_h$. In this case, the forbidden region is all the space above the solid line. To help the user to know whether $T(j\omega)$ fulfils the specification, two red points, $T(j\omega_h)$ and $T(j\infty)$, are drawn in the Nichols curve of $T(j\omega)$. To fulfil this specification the Nichols curve between these two points must be below the red solid line.

² Numerically, ITCLSD considers $\omega = 10^{20}$ to approximate $\omega = \infty$.

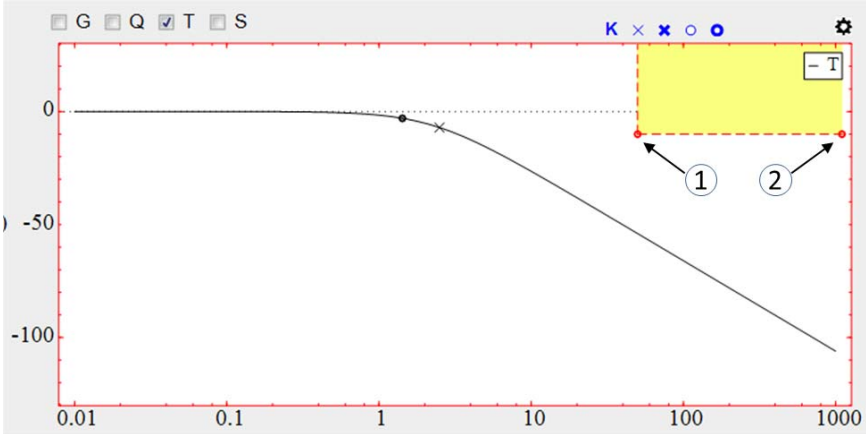

(a)

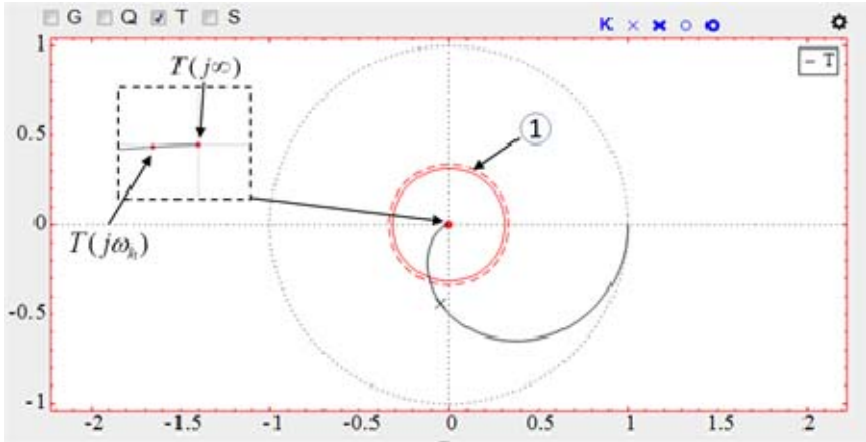

(b)

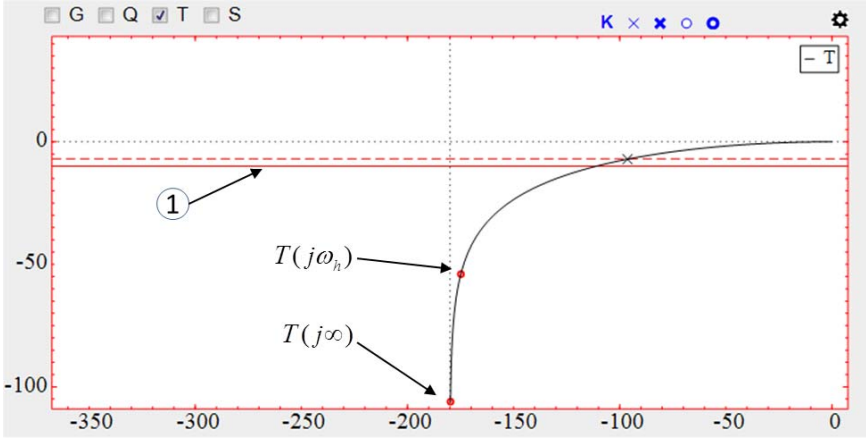

(b)

Figure 28. Specification high frequency disturbances attenuation (HF) for $T(j\omega)$ in a) Bode diagram, b) Polar diagram, and c) Nichols diagram.

If the auxiliary window (see Figure 26a) is displayed on the main window, apart from the text fields, the user can also configure the HF specification dragging certain interactive elements in the *frequency response* zone. In the Bode diagram (see Figure 28a), the user can drag vertically upward or downward the red point 1 to configure m_h , and drag horizontally to left or right the red point 2 to configure ω_h . In the Polar diagram (see Figure 29a), the user can configure m_h dragging the interior circumference 1. And in the Nichols diagram (see Figure 29b), the user can drag vertically upward or downward the red solid line 1 to configure m_h .

- Maximum complementary sensitivity (M_T). This specification is defined as

$$\max_{\omega} \{|T(j\omega)|\} \leq M_T \quad (25)$$

It have one parameter M_T , which can be configured by a text field in the auxiliary window (see Figure 26a) if the specification has been previously enabled. Note that M_T cannot be greater than 12 dB. Depending of the frequency diagram, the specification has a certain graphical representation:

- Bode diagram (see Figure 29a). The specification takes the form of a yellow rectangle, which defines a forbidden region for $|T(j\omega)|$. The lower bound of this region is M_T dB. $|T(j\omega)|$ must be outside the yellow rectangle to fulfil the specification.
- Polar diagram (see Figure 29b). The specification takes the form of two magenta circumferences: one exterior circumference (dashed line), and one interior circumference (solid line). The radius of the interior circumference is M_T (expressed in arithmetic units). It establishes a boundary for $T(j\omega)$. The exterior circumference is drawn to indicate where is the forbidden region for $T(j\omega)$. In this case, the allowed region is the disk of radius M_T (expressed in arithmetic units). To help the user to know whether $T(j\omega)$ fulfils the specification, $T(j\omega_{xT})$ is drawn as a magenta point in the polar curve of $T(j\omega)$, ω_{xT} is the frequency of the

maximum $|T(j\omega)|$. To fulfil this specification the polar curve must be inside the interior circumference.

- Nichols diagram (see Figure 29c). The specification takes the form of two magenta horizontal lines: one solid line, and one dashed line. The magnitude in dB of the solid line is M_T . It establishes a boundary for $T(j\omega)$. The dashed line is drawn to indicate where is the forbidden region for $T(j\omega)$. In this case, the forbidden region is all the space above the solid line. To help the user to know whether $T(j\omega)$ fulfils the specification, $T(j\omega_{xT})$ is drawn as a magenta point in the polar curve of $T(j\omega)$. To fulfil this specification the Nichols curve must be below the magenta solid line.

If the auxiliary window (see Figure 26a) is displayed on the main window, apart from the text field, the user can also configure the value of M_T dragging certain interactive element in the *frequency response* zone. In the Bode diagram (see Figure 29a), the user can drag vertically upward or downward the red point 1. In the Polar diagram (see Figure 29b), the user can configure M_T dragging the interior circumference 1. And in the Nichols diagram (see Figure 29c), the user can drag vertically upward or downward the magenta solid line 1.

ITCLSD implements two frequency specifications to design $S(s)$:

- *Low frequency disturbances attenuation* (LF).. This specification is defined as

$$|S(j\omega)| \leq m_l \quad \forall \omega \leq \omega_l \quad (26)$$

It have two parameters m_l and ω_l , which can be configured by two text fields in the auxiliary window (see Figure 26b) if the specification has been previously enabled. Note that m_l cannot be greater than 0 dB.

Depending of the frequency diagram, the specification has a certain graphical representation:

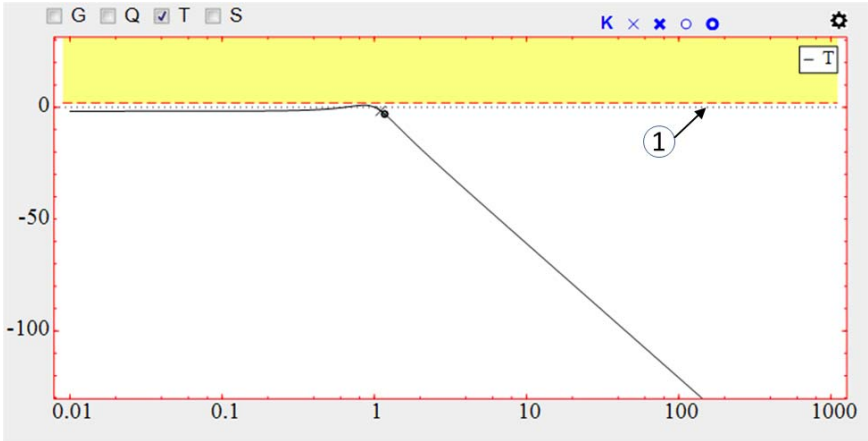

(a)

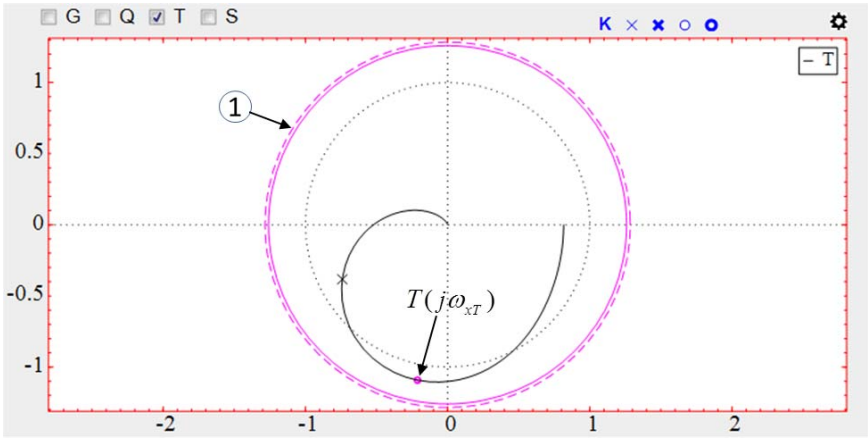

(b)

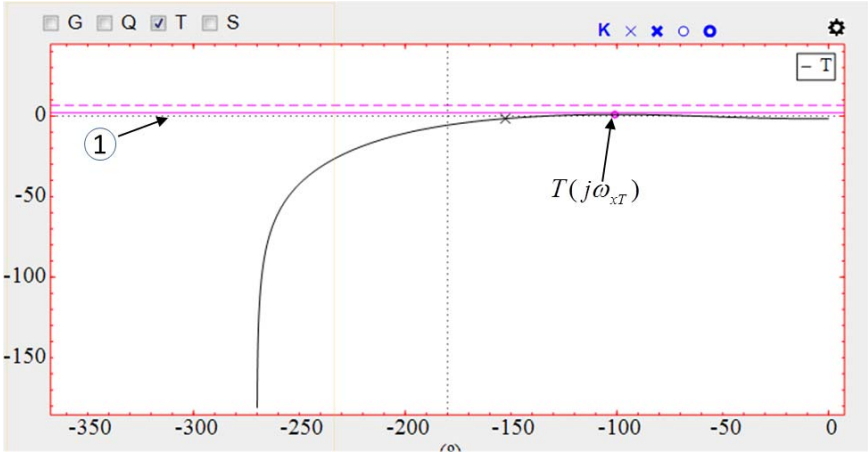

(c)

Figure 29. Specification maximum complementary sensitivity in a) Bode diagram , b) Polar diagram, and c) Nichols diagram.

- Bode diagram (see Figure 30a). The specification takes the form of a yellow rectangle, which defines a forbidden region for $|S(j\omega)|$. The width of this region is ω_l , and the lower bound is m_l dB. $|S(j\omega)|$ must be outside the yellow rectangle to fulfil the specification.
- Polar diagram (see Figure 30b). The specification takes the form of two circumferences: one exterior circumference in blue dashed line, and one interior circumference in blue solid line. The radius of the interior circumference is m_l (expressed in arithmetic units). It establishes a boundary for $S(j\omega)$ if $\omega \leq \omega_l$. The exterior circumference is drawn to indicate where is the forbidden region for $S(j\omega)$ if $\omega \leq \omega_l$. In this case, the allowed region is the disk of radius m_l (expressed in arithmetic units). To help the user to know whether $S(j\omega)$ fulfils the specification, two blue points, $S(j0)$ and $S(j\omega_l)$, are drawn in the polar curve of $S(j\omega)$. To fulfil this specification the polar curve between these two points must be inside the interior circumference.
- Nichols diagram (see Figure 30c). The specification takes the form of two blue horizontal lines: one solid line, and one dashed line. The magnitude in dB of the solid line is m_l . It establishes a boundary for $S(j\omega)$ if $\omega \leq \omega_l$. The dashed line is drawn to indicate where is the forbidden region for $S(j\omega)$ if $\omega \leq \omega_l$. In this case, the forbidden region is all the space above the solid line. To help the user to know whether $S(j\omega)$ fulfils the specification, two blue points, $S(j0)$ and $S(j\omega_l)$, are drawn in the Nichols curve of $S(j\omega)$. To fulfil this specification the Nichols curve between these two points must be below the red solid line.

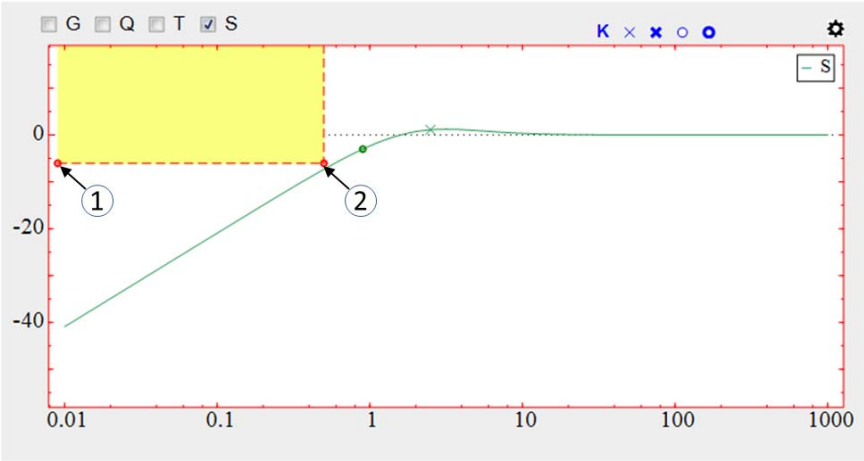

(a)

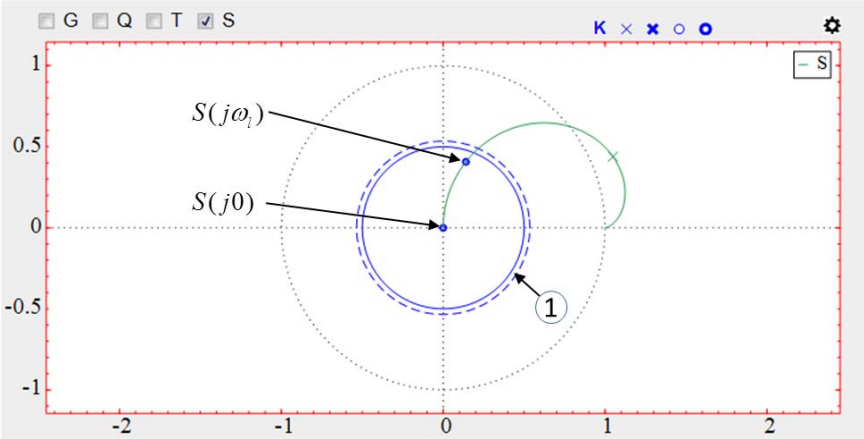

(b)

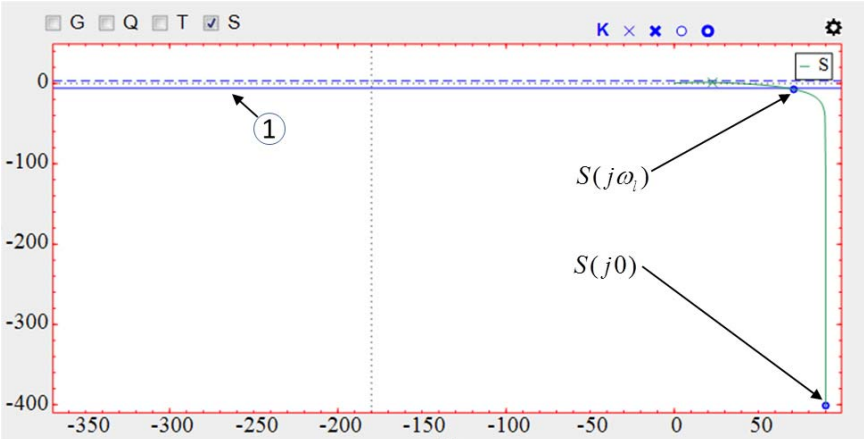

(c)

Figure 30. Specification low frequency disturbances attenuation (LF) for $S(j\omega)$ in a) Bode diagram , b) Polar diagram, and c) Nichols diagram.

If the auxiliary window (see Figure 26b) is displayed on the main window, apart from the text fields, the user can also configure the LF specification dragging certain interactive elements in the *frequency response* zone. In the Bode diagram (see Figure 30a), the user can drag vertically upward or downward the red point 1 to configure m_l , and drag horizontally to left or right the red point 2 to configure ω_l . In the Polar diagram (see Figure 30b), the user can configure m_l dragging the interior circumference 1. And in the Nichols diagram (see Figure 30c), the user can drag vertically upward or downward the red solid line 1 to configure m_l .

- Maximum complementary sensitivity (M_s). This specification is defined as

$$\max_{\omega} \{|S(j\omega)|\} \leq S_T \quad (27)$$

It have one parameter M_s , which can be configured by a text field in the auxiliary window (see Figure 26b) if the specification has been previously enabled. Note that M_s cannot be greater than 12 dB. Depending of the frequency diagram, the specification has a certain graphical representation:

- Bode diagram (see Figure 31a). The specification takes the form of a yellow rectangle, which defines a forbidden region for $|S(j\omega)|$. The lower bound of this region is M_s dB. $|S(j\omega)|$ must be outside the yellow rectangle to fulfil the specification.
- Plot diagram (see Figure 31b). The specification takes the form of two red circumferences: one exterior circumference (dashed line), and one interior circumference (solid line). The radius of the interior circumference is M_s (expressed in arithmetic units). It establishes a boundary for $S(j\omega)$. The exterior circumference is drawn to indicate where is the forbidden region for $S(j\omega)$. In this case, the allowed region is the disk of radius M_T (expressed in arithmetic units). To help the user to know whether $S(j\omega)$ fulfils the specification, $S(j\omega_{xS})$ is drawn as a red point in the polar curve of $S(j\omega)$, ω_{xS} is the frequency of the maximum $|S(j\omega)|$. To fulfil this specification the polar curve must be inside the interior circumference.

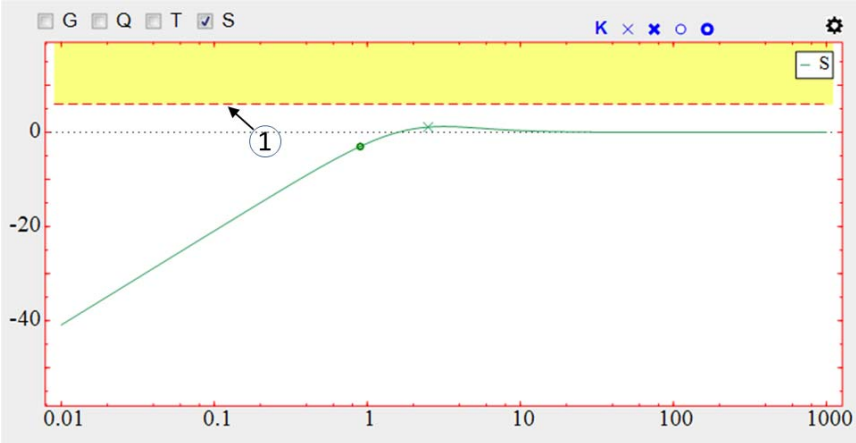

(a)

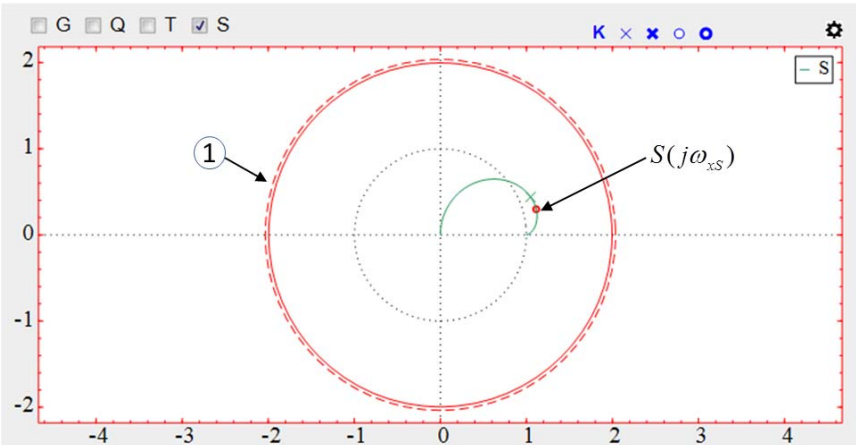

(b)

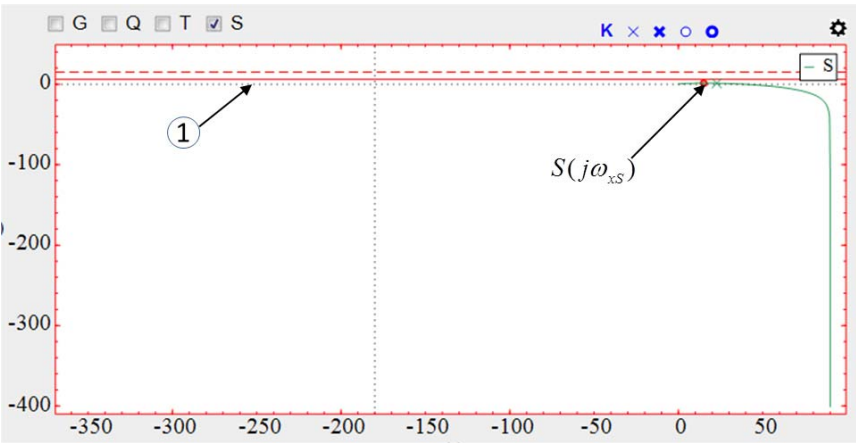

(c)

Figure 32. Specification maximum sensitivity in a) Bode diagram , b) Polar diagram, and c) Nichols diagram.

- Nichols diagram (see Figure 31c). The specification takes the form of two red horizontal lines: one solid line, and one dashed line. The magnitude in dB of the solid line is M_s . It establishes a boundary for $S(j\omega)$. The dashed line is drawn to indicate where is the forbidden region for $S(j\omega)$. In this case, the forbidden region is all the space above the solid line. To help the user to know whether $S(j\omega)$ fulfils the specification, $S(j\omega_{xS})$ is drawn as a red point in the polar curve of $S(j\omega)$. To fulfil this specification the Nichols curve must be below the red solid line.

If the auxiliary window (see Figure 26b) is displayed on the main window, apart from the text field, the user can also configure the value of M_s dragging certain interactive element in the *frequency response* zone. In the Bode diagram (see Figure 31a), the user can drag vertically upward or downward the red point 1. In the Polar diagram (see Figure 31b), the user can configure M_s dragging the interior circumference 1. And in the Nichols diagram (see Figure 31c), the user can drag vertically upward or downward the red solid line 1.

11. Time performance/specifications

The *performance/specifications* zone is located in the left central part of the ITCLSD main window (see Figure 3). Figure 23 shows the appearance of this zone when there are not specifications selected. In this case, the buttons *Frequency specifications* and *Time Specifications* is in yellow colour. Besides, there is a table with frequency and time characteristics. In the right part of this zone, the following parameters of the system step response $y(t)$ [Ogata, 2009] are shown:

- Maximum overshoot percentage P_o . It is the maximum peak value of the response curve measured from unity in percentage. If the closed loop system is unstable, the value NaN is shown in the table.
- Rise time t_r . It is the time required for the response to go from 10% to 90% of its final value. If the closed loop system is unstable, the value NaN is shown in the table.
- Settling time t_s . It is the time required for the response curve to reach and thereafter remain within a 2% percentage of its final value. If ITCLSD cannot

compute automatically t_s , then the value -1 is shown in the table. In this case, the user has to increase the simulation time t_{\max} in the auxiliary window of the *time response* zone (see Figure 22). If the closed loop system is unstable, the value NaN is shown in the table.

- Steady state error percentage e_s . It defines as

$$e_s = 100 \cdot \lim_{t \rightarrow \infty} |\varepsilon(t)| = 100 \cdot \lim_{t \rightarrow \infty} |r(t) - y(t)| \quad (28)$$

If there is some enabled specification this table is hidden. To show the table with the time and frequency characteristics, the user has to type the key {e}. To hide this table and see the enabled specifications, the user has to type again the key {e}.

ITCLSD implements five time specifications (see Figure 32). To enable or disable a certain specification, the user has to do the following steps:

1. Click on the button *Time specifications*. When the user does this action, an auxiliary window (see Figure 33) is show on the screen.
2. Click on the checkmarks associated to the specifications that you want to enable or disable.
3. Click on OK.

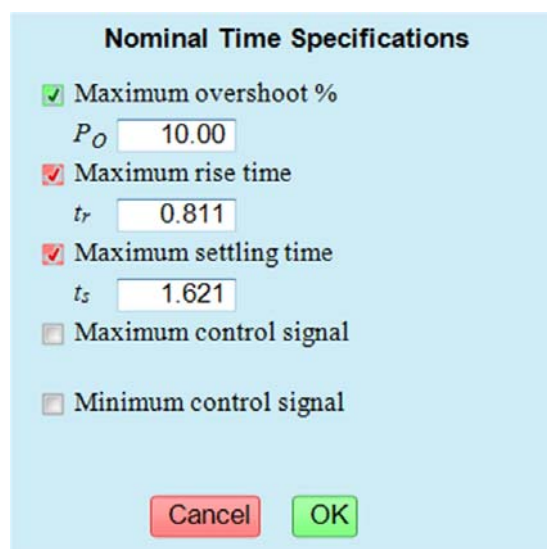

Figure 32. Auxiliary window to configure the time specifications

When there are enabled time specifications, the *performance/specifications* zone changes its appearance, and it only shows information about the enable specifications.

To set the value of a enabled specification, the user has to do the following steps:

1. Click on the button *Time specifications*. When the user does this action, an auxiliary window (see Figure 33) is show on the screen.
2. Write the value in the text field below the specification. Besides, some specifications can be set dragging some interactive element associated to this specification in the *time response* zone.
3. Click on OK.

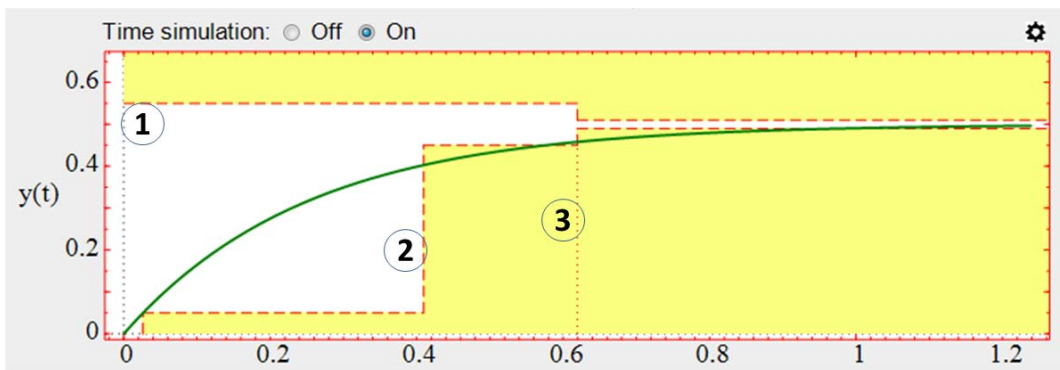

Figure 33. Interactive elements to set the specifications P_o , t_r , and t_s

The specifications *maximum percentage overshoot* P_o , *maximum rise time* t_r , and *maximum settling time* t_s define forbidden (yellow) areas where $y(t)$ does not have to pass. These three specifications can be set by text fields or by dragging the corresponding interactive element (see Figure 33):

- To set P_o , the user has to drag vertically the red dotted horizontal line 1.
- To set t_r , the user has to drag horizontally the red dotted vertical line 2.
- To set t_s , the user has to drag horizontally the red dotted vertical line 3.

The specifications *maximum control signal* u_h , and *minimum control signal* u_l define forbidden (yellow) areas where $u(t)$ does not have to pass. These two specifications can be set by text fields or by dragging the corresponding interactive element (see Figure 34):

- To set u_h , the user has to drag vertically the red dotted horizontal line 1.
- To set u_l , the user has to drag vertically the red dotted vertical line 2.

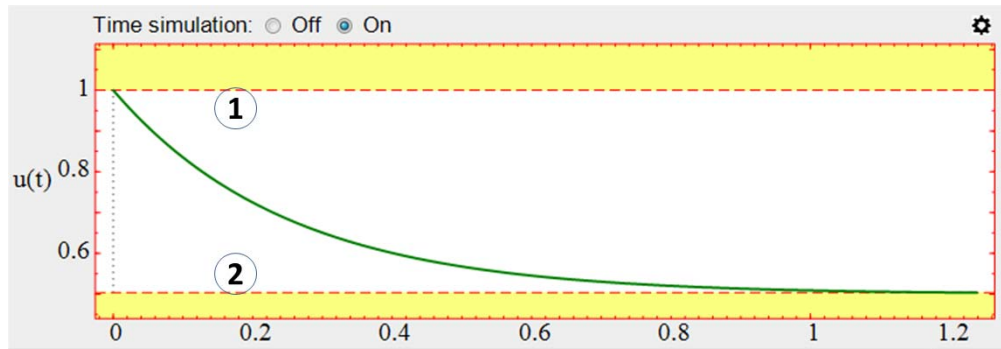

Figure 34. Interactive elements to set the specifications u_h and u_l

12. Save and load a work session

A *work session* refers to the state of ITCLSD in a certain time T . Such state is defined by the values of the data and variables used by ITCLSD in T .

ITCLSD allows saving a work session. To do that, the user has to type the key $\{s\}$, or click on the menu entry *Session/Save session*. When the user executes some of these actions, a dialog box is shown in the screen where he/she must write the name of the work session file that he wants to save. By default, the file name has the following structure:

$$\text{ITCLSD}_{[\text{year}]_{[\text{month}]_{[\text{day}]_{[\text{time}].\text{dat}}}}$$

For example: ITCLSD_2018_9_7_101955.dat

To load a work session, the user has to type the key $\{l\}$, or click on the menu entry *Session/Load session*. When the user executes some of these actions, a dialog box is shown in the screen where he/she must write the name of the work session file that he wants to load.

13. Save a report

ITCLSD allows saving a *report* file with the following data: G , Q , C , H , time and frequency specifications, and system performance. To generate a report, the user has to type the key $\{a\}$, or click on the menu entry *Session/Save report*. When the user executes some of these actions, a dialog box is shown in the screen where he/she must write the name of the report file. By default, the file name has the following structure:

ITCLSD_report_[year]_[month]_[day]_[time].html

For example: ITCLSD_report_2018_9_7_101955.html. Note that the work session is also saved with the same name of the report.

14. Menu options

In the upper part of the ITCLSD main window, there are four menus (see Figure 1): *Session*, *Options*, *Info*, and *Help*.

The menu *Session* has four entries:

- *Load session*. The shortcut for this menu entry is the key $\{l\}$. See section 12.
- *Save session*. The shortcut for this menu entry is the key $\{s\}$. See section 12
- *Save report*. The shortcut for this menu entry is the key $\{a\}$. See section 13.
- *Reset*. When the user clicks on this menu entry, ITCLSD recovers its start-up values.

The menu *Options* has three entries:

- *Frequency range for validation*. ITCLSD allows setting the following parameters to do the frequency validation: number of points N , lower frequency 10^{d_1} , and higher frequency 10^{d_2} . When the user clicks on this menu, a dialog box is shown in the screen where user must write N , d_1 , and d_2 . By default, $N = 1000$, $d_1 = -3$, $d_2 = 3$.
- *Time simulation settings*. ITCLSD allows the user to set four parameters of the Sysquake ordinary differential equations (odes) solvers that are used for the time simulation:

- *Maximum absolute error* 10^{-d} ($d= 3, 4, 5, \text{ or } 6$). By default, it is set to 10^{-4} .
- *Maximum relative error* 10^{-d} ($d= 1, 2, 3, \text{ or } 4$). By default, it is set to 10^{-3} .
- *Refinement factor ode23s*. It is the refinement factor that is used for the solver of stiff systems of Sysquake, the function `ode23s`. This factor specifies how many points are added to the result for each integration step. When it is larger than 1, additional points are interpolated. By default, this parameter is set to 1. To display the effect of this parameter, click on the gearwheel icon located in the right upper corner of the zone Time Response (see Figure 20). When the user does this action, an auxiliary window is shown (see Figure 22). Select Yes in the option Show Points.
- *Refinement factor ode45*. It is the refinement factor that is used for the solver of non-stiff systems of Sysquake, the function `ode45`. This factor specifies how many points are added to the result for each integration step. When it is larger than 1, additional points are interpolated. By default, this parameter is set to 4. To display the effect of this parameter, click on the gearwheel icon located in the right upper corner of the zone Time Response (see Figure 20). When the user does this action, an auxiliary window is shown (see Figure 22). Select Yes in the option Show Points.

A low value for the maximum absolute or relative error increases the computation time. A high value for the refinement factor also increases the computation time.

- *Default structure of F_q denominator for PID design*. If a PID controller has been selected (see section 4), and the filter $F_q(s)$ has two poles, then ITCLSD allows the user choosing the kind of poles: real or complex. Besides, in the case of a first order plant with an integrator, where $F_q(s)$ has three poles [Goodwin et al., 2001], the tool allows choosing between: three real poles or one real pole and two complex poles.

The menu *Info* has two options:

- *About*. When the user clicks on this menu, a dialog box is shown with information about the number version and authors.
- *Help*. When the user clicks on this menu, the ITCLSD web page is opened in a default computer browser.

Finally, the menu *Help* has the option *About This Application...* that shows a dialog box with the Sysquake logo, to remind that this application has been developed in Sysquake [Piguet, 2017].

APPENDIX A. Colour code

Transfer function	Colour
Plant G_n	Red
Filter Q	Blue
Controller C	Blue
Prefilter H	Blue
Open loop L	Black
Complementary sensitivity T	Black (Q design) Red (H design)
Sensitivity S	Green
$H \cdot T$	<i>Black</i>

Table 3. Colour code

APPENDIX B. Keyboard shortcuts

Key	Meaning
0	Show the frequency response to small size (only available for Bode diagram)
1	Show the frequency response to medium size
2	Show the frequency response to large size
3	Show the frequency response to huge size
e	Show or hide the table of time and frequency characteristics
l	Load session
s	Save session
a	Generate report
b	Show bode diagram
p	Show polar diagram
n	Show Nichols diagram
v	Set the scale to variable type in all the figures
k	Set the scale to locked type in all the figures

Table 4. Keyboard shortcuts

BIBLIOGRAPHY

- [Åström and Murray, 2008] Åström, K. J. and Murray, R. (2008) Feedback Systems: An Introduction for Scientists and Engineers, Princeton University Press
- [Goodwin et al., 2001] Goodwin, G. C., Graebe, S. F., Salgado, M. E. (2001). Control system design. Prentice Hall.
- [Ogata, 2009] K. Ogata. Modern Control Engineering. Pearson. 5th Edition. 2009.
- [Piguet, 2017] Piguet, Y. (2017) Sysquake Pro 6.0 User Manual. Calerga Sarl. www.calerga.com.
- [Skogestad and Postlethwaite, 2005] Skogestad, S. and Postlethwaite, I. (2005). Multivariable Feedback Control. Wiley, Hoboken, NJ, 2nd edition.

